

D

Pos-E-Kon® - Industrial connectors



—
D

Pos-E-Kon - Industrial connectors

Table of contents

Section D

Overview	D4
A Series 16 A, 600 V AC	D16
B Series 16 A, 600 V AC	D18
C Series 35 A, 600 V AC	D22
D Series 10 A, 600 V AC	D24
DD Series 10 A, 600 V AC	D28
K Series 80 + 16 A, 600 V AC	D32
V Series 16 A, 600 V AC	D34
T Series 16 A, 600 V AC	D38
Technical information	D40

Overview

The FAQs about Pos-E-Kon interconnects

ABB interconnects adhere to international standards and are used worldwide to provide a high degree of reliability in electrical wiring.

Why?

Rectangular circuit interconnections

- Best use of space for multiple contacts in heavy-duty housings
- Easy to assemble with many different insert options
- Best fit for easy access in panels, machinery and enclosures
- Sealed connector with quick disconnect handles
- Wide variety of circuit possibilities from standard items
- Solid or stranded wire in fixed or portable use

Who?

- Machine tool OEMs
- Material handling equipment OEMs
- Robotics systems OEMs and installations
- Packaging machinery OEMs and facilities
- Control panels and PLC systems
- Molding, assembly or line machinery OEMs and facilities
- Construction, mining and welding apparatus
- Carnival applications

What?

- Servo controls
- Sensing and feedback loops
- Conveyor and process controls
- Low power, DC or logic systems
- Combination power, system and other circuits
- Modular controls including fiber-optic connections

Where?

Worldwide agency approvals and applications

- DIN VDE 0627/86, 0110/02.79, and 0110-1/04.97
- IEC 60.664-1, DIN/IEC 512
- UL® recognized (E215386) and CSA certified
- Protection classes IP44 through IP65 per IEC 529
- Component use in CE marked equipment OK per IEC
- Council Directive July 1999, 73/23/EEC
- Available from ABB – Pos-E-Kon authorized distributors
- ABB sales representatives and agents worldwide

DIN standard configurations

- Most inserts and housings are interface compatible with other DIN standard lines. Verify physical application before selecting cross reference.
- Pos-E-Kon construction includes standard NPT conduit adapters for hoods and bases, with many options available. DIN standard Hoods and Bases may have “Euro Style” PG fittings (or none) included unless specially ordered.

The basic system: build an application

- Step 1** – Maximum voltage and amperage requirements (300 V or 600 V classes, 10–80 A).
- Step 2** – Number of contacts or circuits needed.
- Step 3** – Choose wire terminations style; screw terminal or crimp contacts. Select series from charts.
- Step 4** – Base (or coupler) and hood construction/ mating selection per series (single or double levers).



01

- 01 Hood
- 02 Base housing (or coupler hood)

Step 1

Hood:

- Separable housing for inserts
- Top or side conduit/wire entry
- Standard locking posts, dual or single
- Locks to panel base, box base or inline coupler hood



02

Step 2

Base housing (or coupler hood):

- Surface wall-mount box base (shown)
- Panel base for through-panel access
- Coupler hood mating for portable use
- Single or dual “lever” locking



03

- 03 Male insert
- 04 Female insert

Step 3

Male insert:

- Male contact carrier body
- Screw terminal contacts (pins with wire protection saddles) or crimp terminated pins

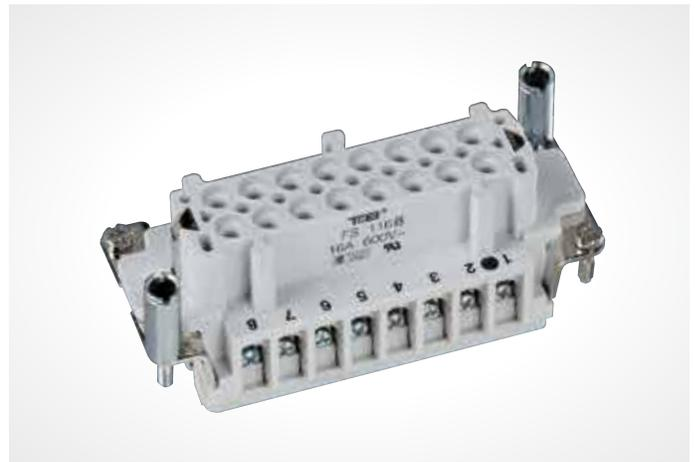

04

Step 4

Female insert:

- Female contact carrier
- Screw terminal contacts (sleeves with wire protection saddles) or crimp terminated sleeves

Overview

Pos-E-Kon insert selector chart

S – Screw terminals **C** – Crimp contacts
F – Fiber optic (POF) **A** – Terminal block wiring adapter

Select the number of contacts – All inserts have separate ground contacts

Amps	Volts	Series	3	4	6	7	8	10	12	15	16	20	24	25	26	32	40	42	48	50-216	
10	50	D	-	-	-	-	C, F	-	-	-	-	-	-	-	-	-	-	-	-	-	
10	600	A	S	S	-	-	-	-	-	-	-	-	-	-	-	-	-	-	-	-	
16	600	A	-	-	-	-	-	S, C	-	-	S, C	-	-	-	-	S, C	-	-	-	-	
16	600	B	-	-	S, C, A	-	-	S, C, A	-	-	S, C, A	-	-	-	-	S, C	-	-	S, C	-	
35	600	C	-	-	S	-	-	-	S	-	-	-	-	-	-	-	-	-	-	-	
10	600	D	-	-	-	C, F	-	-	-	C, F	-	-	-	C, F	-	-	C, F, A	-	-	C, F, A (64)	
10	600	DD	-	-	-	-	-	-	-	-	-	-	C, F	-	-	-	-	C, F	-	C, F	
80/16	600	K	-	S	-	-	S	4 or 8 Power (80 A alone or with 8 or 16 control (16 A) combination inserts)													
16-T	600	T	-	-	S	-	-	S	-	-	S	-	S	High temp (200 °C)							
316-V	600	V	S, C	-	S, C	-	-	S, C	-	-	S, C	S, C	-	-	S, C	S, C	Includes 2 pilot contacts				

10-16 A A, B, V, T	35 A C	10-80 A K
		

Screw terminal/Insert types (Integral contacts)

Screw termination is used for ease of assembly plus ease of maintenance. No tooling beyond a screwdriver and wire strippers is required.

10 A D & DD	16 A A & B
	

Crimp terminal/insert types (Crimp contacts)

Crimp terminals offer solid, thermally cool vibration-resistant terminations for OEM equipment and critical applications. Better for smaller AWG sizes also. Crimp tools are noted in each section.

10-16 A A, B	10 A D & DD	POF D
		
		

All crimp types represented require contacts ordered separately. Each section contains hand crimp tool selection notes



01

01 Screw terminal inserts

02 Crimp terminal inserts

03 Terminal block wiring adapters

Screw terminal inserts*

- Integral screw terminal contacts provide for easy terminal wiring and fast assembly
- Standard wire protection saddles prevent cutting of strands during assembly



02

Crimp terminal inserts*

- Provides reliable connections for long-term configurations
- Contact sizes accommodate wiring from 12-20 AWG

* Note:

- Made of durable glass fiber-filled thermoplastic
- Contact numbers clearly marked for easy identification
- Easily installed (male or female) in either hoods or bases using captive mounting screws



03

WAM1 marker tab clips
Snap-in formed label holder tabs allow terminal identification for B Series.

DIN Mounting Foot FE807TB

WAR, right ground strap
WAL, left ground strap

Terminal block wiring adapters

- Allows for measuring of circuit while in operation
- Provide easy connections in panel mounting configurations
- Labels available for easy identification of circuits
- Can be mounted on DIN rails by using snap-on mounting feet
- Used in switch cabinets, panel enclosures or mounted in panel base housings – see B and D series

Insert strip blank – WAM1B

Insert strip numbers 1–64 – WAM1N64

Insert strip letters A–Z – WAM1AZ

* Made of durable glass fiber-filled thermoplastic
Contact numbers clearly marked for easy identification
Easily installed (male or female) in either hoods or bases using captive mounting screws

Overview

Hood and base housings

- 01 Box base
- 02 Top cable entry
- 03 Panel base
- 04 Side cable entry
- 05 Box base housing with single lever and spring cover. Metal spring covers available for B series, where noted.

- Rugged cast aluminum hoods and bases: Maximum performance in many operating conditions
- Various hood heights available: Easier assembly and wiring with low, high and standard profiles
- Corrosion-resistant finishes: Optional special materials extend life in corrosive conditions
- Locking possibilities include single locking system and double locking system
- Complete selection: Flexible product designs (see Hood/Base cross reference below)
- Dust covers and more: See adapters (page 10) and covers (page 10) or bases with covers available in most series (accessories, pages 58–62)
- Custom configurations: Multiple conduit entry/ sizes and other configurations available to spec



— 01



— 02



— 05



— 03



— 04

Cross reference – Inserts

Amps	Volts	Series	A4	A10	A16	AA32	B6	B10	B16	B24	B32	B48
Series application			Standard hood/base housing									
10	50	D	D8	–	–	–	–	–	–	–	–	–
10	600	A	A3, A4	–	–	–	–	–	–	–	–	–
16	600	A	–	A10	A16	A32	–	–	–	–	–	–
16	600	B	–	–	–	–	B6	B10	B16	B24	B32	B48
35	600	C	–	–	–	–	–	–	C6	–	C12	–
10	600	D	D7	D15	D25	D50	–	–	D40	D64	D80	D128
10	600	DD	–	–	–	–	DD24	DD42	DD72	DD108	DD144	DD216
80/16	600	K	–	–	–	–	–	–	–	K4/8	–	K8/16
Series application			Special series hood/base housing									
16-T*	600	T	–	–	–	–	T6	T10	T16	T24	–	–
16-V**	600	V	–	–	–	–	–	V3	V6	V10	–	V32

* Special high-temperature series in copper-free aluminum with special green epoxy powder coat, Viton® seals.†

** Special isolation design allows additional control circuit capability.

† Viton is a trademark of DuPont Performance Elastomers.

Overview

- 1) Select size (number of contacts) from each series' section left-hand page chart (selected inserts), then look at corresponding right-hand page columns.
- 2) Vertical columns note single or double locking systems available (double locking usually preferable).
- 3) Select base housings for mounting and/or function: conduit/cable entry, thru-panel access, inline coupler or reversed locking as shown. (Note profile height options.)
- 4) Select side or top entry hoods as shown. (Note profile height options.)
- 5) Review conduit and cable entry options (standard NPT adapter sizes for each series).

Note: M Series (layout) groups interior options, followed by base selection options.

Each right-hand page shows:		
	<p>Standard bases</p> <hr/> <p>Standard hoods</p>	<p>BASE TO HOOD</p>
	<p>Portable service</p> <p>Coupler hoods</p>	<p>HOOD TO COUPLER</p>
	<p>Reverse locking</p> <p>Lever hoods</p> <hr/> <p>Post bases</p>	<p>BASE TO HOOD</p>

Overview

— 01 Sub-miniature (DB) adapter plates

— 02 B24 insert mounting adapter plates

— 03 Dust covers (thermoplastic) & hinged covers (thermoplastic or metal)



— 01

Sub-miniature (DB) adapter plates

- Connect test and diagnostic equipment to control circuits
- Panel base, box housing base or any hood installation (ribbon cable – entry hoods available)
- Industry standard sizes
- Dust covers for protection recommended
- 9, 15, 25, 37 and 50 series



— 02

B24 insert mounting adapter plates

- Allows housing standardization for multiple applications
- B24 footprint fit to single B6, B10, B16 inserts
- Rugged thermoplastic
- Fits standard B24 hoods and bases

B24 insert mounting adapter plates

- Allows custom connections for drill-and-install work
- Blank plate for expansion
- All standard hood/base sizes supported



— 03

Dust covers (thermoplastic) and hinged covers (thermoplastic or metal)

- Separate covers or fixed-mount hinged types
- Metal fixed-mount hinged covers for B series bases available in select sizes
- Separate or fixed covers protect contacts when not in use or while unmated
- Refer to p. 58

Overview

Wire and cable entry options



01

- 01 Cable compression seal fitting
- 02 Euro gland seal
- 03 Standard NPT conduit adapters
- 04 Cord grip fittings
- 05 Pos-E-Kon advantages



02

Portable service cord

- Sheathed industrial multi-conductor cables usage
- Options cover many installation needs
- Special constructions available for retrofit or original specification
- Hoods and bases may be specified (in bulk volumes)
- Euro standard gland seal also available
- Refer to p. 61

Cord grip fittings

- Both NPT and PG thread styles
- Thermoplastic sealing glands in NPT, PG and ISO threads – for retrofit or original specification
- More options than shown are available (shown in gray; black also available)
- Refer to p. 62



03

Standard NPT conduit adapters

- Euro PG to NPT thread adapters (PG male to NPT female)
- Standard on all Pos-E-Kon hoods and bases
- Available separately for MRO
- Sizes from PG11 to 1/2" through PG48 to 1 1/2" NPT
- Refer to p. 61

Pos-E-Kon advantages

- Feature: Ergonomic thermoplastic levers for "B" series double-lever housings B10–B24
- Benefits: Non-slip comfortable grip for easier locking and unlocking
- Feature: Laser-etched labeling for all metal housings and hot-stamped labeling on contact carrier inserts
- Benefits: Permanent marking with all data combined in external marking vs. internal label



04



05

Overview

Easy-to-use catalogue number selection

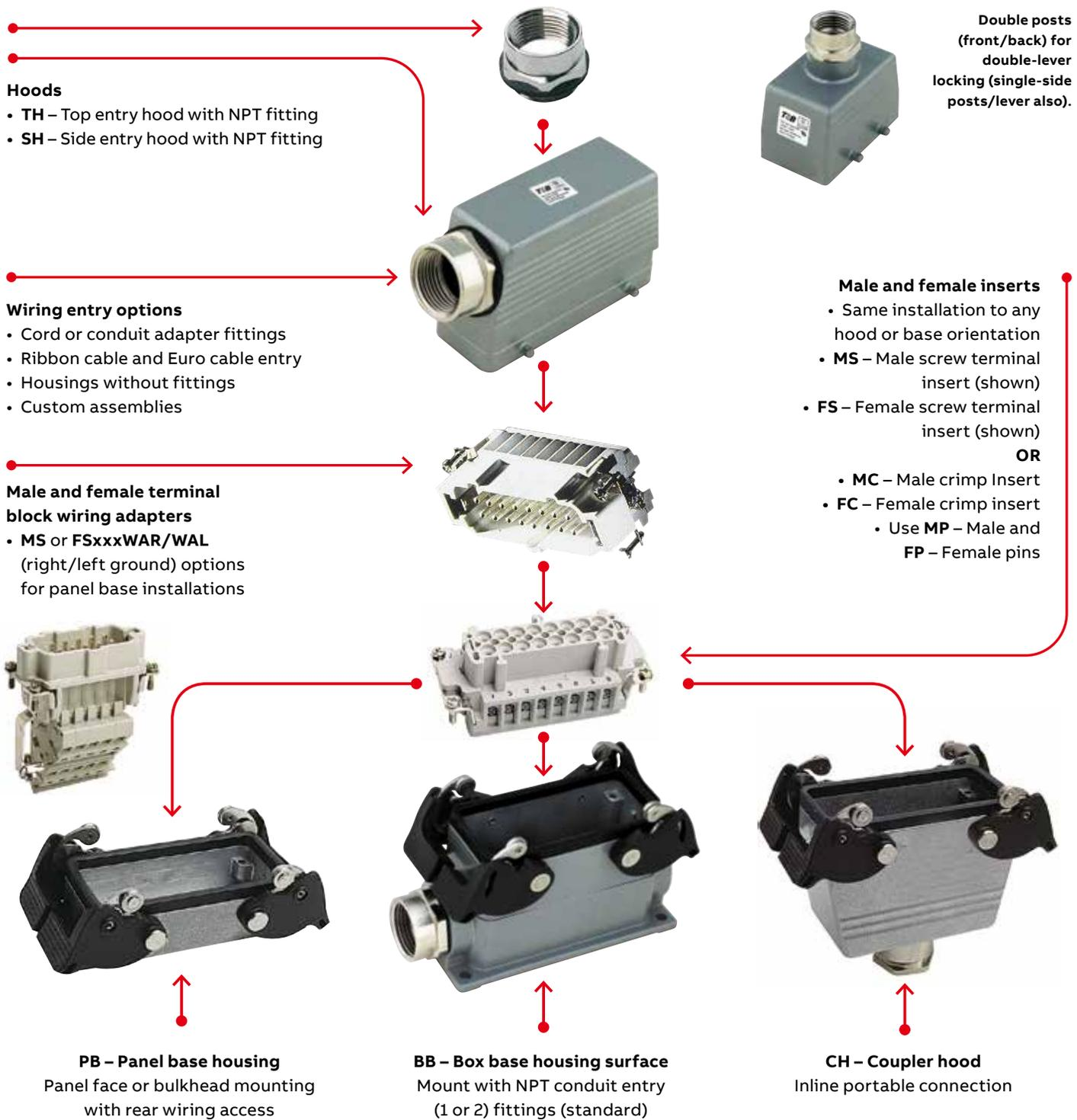

Hoods

- TH – Top entry hood with NPT fitting
- SH – Side entry hood with NPT fitting

Wiring entry options

- Cord or conduit adapter fittings
- Ribbon cable and Euro cable entry
- Housings without fittings
- Custom assemblies

Male and female terminal block wiring adapters

- MS or FSxxxWAR/WAL (right/left ground) options for panel base installations

Double posts (front/back) for double-lever locking (single-side posts/lever also).

Male and female inserts

- Same installation to any hood or base orientation
- MS – Male screw terminal insert (shown)
- FS – Female screw terminal insert (shown)

OR

- MC – Male crimp Insert
- FC – Female crimp insert
 - Use MP – Male and FP – Female pins

PB – Panel base housing

Panel face or bulkhead mounting with rear wiring access

BB – Box base housing surface

Mount with NPT conduit entry (1 or 2) fittings (standard)

CH – Coupler hood

Inline portable connection

Locking

- Single lever/single posts or double lever/double posts locking
- “Reversed locking” (levers on hoods) available

Overview

Series locator

Series locator

Type	Series	Features	Contacts + G	Page
	A Series 10 A: 3, 4 16 A: All others	Small, compact size screw terminal	3, 4, 10, 16, 32	16
	B Series 16 A	Standard size screw terminal	6, 10, 16, 24, 32, 48	18
	C Series 35 A	High-current screw terminal	6 or 12	22
	D Series 10 A	High-density crimp contacts or fiber optic contacts	7, 8, 15, 25, 40, 50, 64, 80, 128	24
	DD Series 10 A	Very high-density crimp contacts	24, 42, 72, 108, 144, 216	28
	K Series 16 A/80 A	Combo, high-current/ Std. current screw terminals	16 A: 8 + 4 80 A: 16 + 8	32
	V Series 16 A	Control circuit contacts and B style screw terminals	3, 6, 20, 26, 32	34
	T Series 16 A	B Style at high-temp 200 °C screw terminals	6, 10, 16, 24	38
Reference and accessories		Specs, dimensions, components and fiber optics		40

SUSTAINABLE DEVELOPMENT

Innovation, operational excellence and sustainable development are central to everything we do, reducing our environmental footprint and improving our communities.

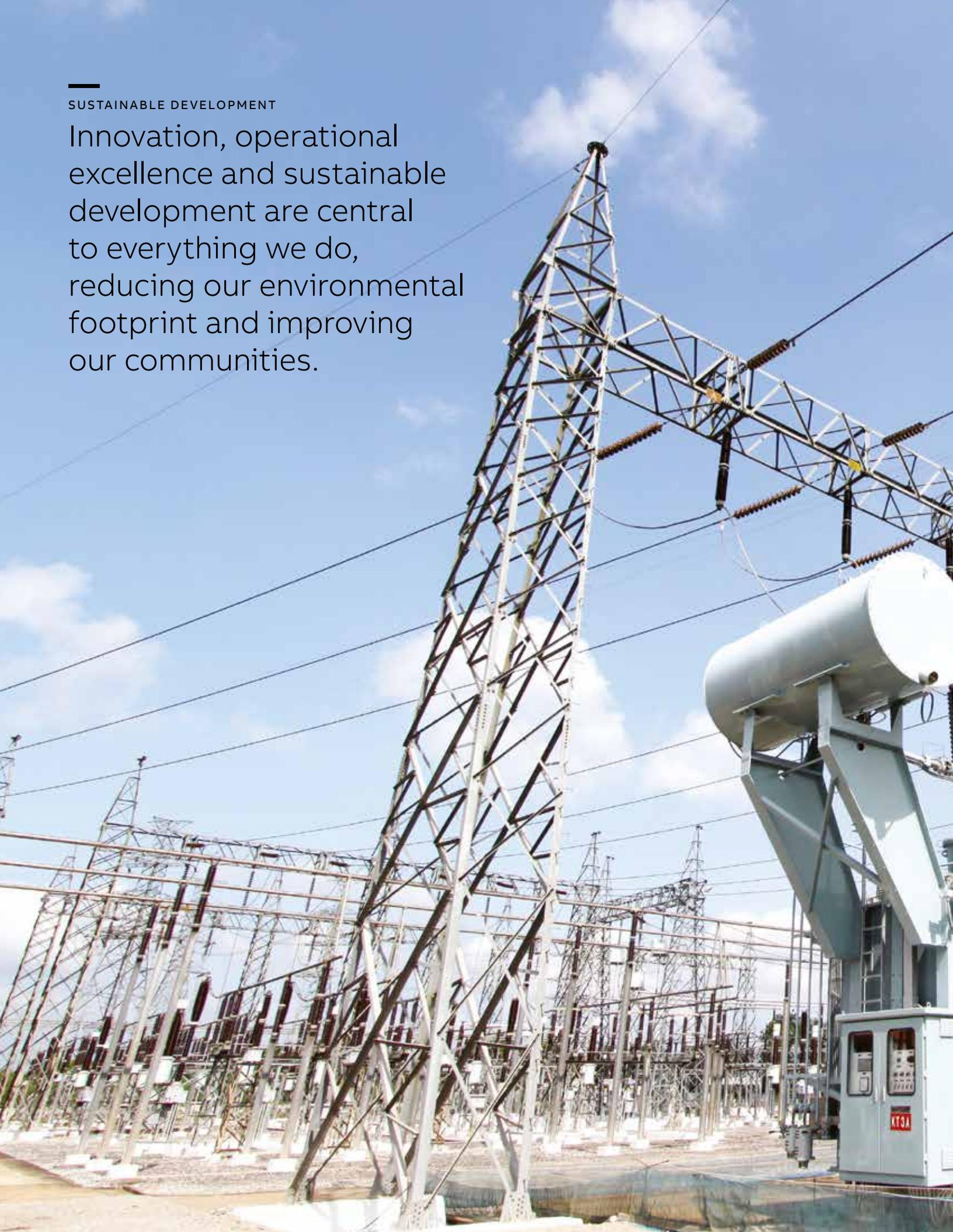



Wire pin & sleeve connectors

A Series 16 A, 600 V AC 3 or 4 contacts + ground: 10 A – 10, 16 & 32 contacts + ground: 16 A



01

Install to matching series hood/base

3 or 4 (600 V)	10	16	32

Screw terminal inserts

Screw terminal inserts	3 or 4 + G	10 + G	16 + G	32 + G
 <p>Male – pins 20–14 AWG (0.5–2.5 mm²)</p>	MS203A or MS204A (16 AWG max.)	MS210A	MS216A	MS216A+ MS232A
 <p>Female – sleeves 20–14 AWG (0.5–2.5 mm²)</p>	FS103A or FS104A (16 AWG max.)	FS110A	FS116A	FS116A+ FS132A

01 Use small blade screwdriver to push wire entry tab in for easy contact removal.

Crimp tool

Cat. no.
WT611TB



A Series 16 A, 600 V AC

Bases – standard mount		NPT entry (in.)		Number of contacts + ground connection				
				3 or 4 (600 V)	10	16	32	
Single lever	Double lever	Housing	Lever locking type					
			Single	Single	Single	Double		
		Panel base (no cover)	–	PB303A(P) [†]	PB310A	PB316A	PB132A	BASES
		Panel base (w/cover)	–	PB403A	PB410A	PB416A	–	
		Angled (no cover)	–	PB503A(P) [†]	–	–	–	
		Box base (no cover)	1 x 3/8	BB403APMV [†]	–	–	–	
			1 x 1/2	–	BB410AMV	BB416AMV	–	
			1 x 3/4	–	–	–	BB032AMV	
			1 x 1	–	–	–	BB832A	
			2 x 1/2	–	BB510AMV	BB516AMV	–	
			2 x 3/4	–	–	–	BB132AMV	
			2 x 1	–	–	–	BB132A100	
		Box base (w/cover)	1 x 1/2	–	BB610AMV	BB616AMV	–	
			2 x 1/2	–	BB710AMV	BB716AMV	–	
Hoods – standard mount *plastic body – “A” 3-16 Series standard hoods include gaskets; bases and special hoods do not.								HOODS
		Side entry	1 x 3/8	SH603APMV [†]	–	–	–	
			1 x 1/2	–	SH610AMV**	SH616AMV**	–	
			1 x 3/4	–	SH710AMV**	SH716AMV**	SH032AMV	
			1 x 1	–	–	–	SH132AMV	
		Top entry	1 x 3/8	TH803APMV [†]	–	–	–	
			1 x 1/2	–	TH810AMV**	TH816AMV**	–	
			1 x 3/4	–	TH910AMV**	TH916AMV**	TH232AMV	
			1 x 1	–	–	–	TH332AMV	
Coupler hoods – inline for inline, portable or special service connections. Coupler hoods mate to standard hoods only.								
		Top entry	1 x 3/8	CH803APMV [†]	–	–	–	
			1 x 1/2	–	CH810AMV	CH816AMV	–	
Lever hoods – reverse locking lever hoods mate to post bases only.								HOODS
		Side entry w/ lever(s)	1 x 3/4	–	–	–	LH032AMV	
			1 x 1	–	–	–	LH132AMV	
		Top entry w/ lever(s)	1 x 3/4	–	–	–	LH232AMV	
			1 x 1	–	–	–	LH332AMV	
Bases – with access cover post bases accept lever hoods only.								BASES
		Panel base + posts w/cover	–	–	–	–	PB232A	
		Box base + posts w/cover	1 x 3/4	–	–	–	BB232AMV	
			1 x 1	–	–	–	BB232A100MV	
			2 x 3/4	–	–	–	BB332A	
			2 x 1	–	–	–	BB332A100	

** Low “L” profile may be available. Contact your ABB sales representative.
[†] Indicates glass-filled thermoplastic construction, light gray color (add suffix).
^{*} Indicates glass-filled thermoplastic construction, black color (add suffix); quantity purchase may be required.

BASE TO HOOD
 HOOD TO COUPLER

Wire pin & sleeve connectors

B Series 16 A, 600 V AC – 6, 10 & 16 contacts + ground



01

Screw terminal inserts

	Screw terminal inserts	6 + G	10 + G	16 + G
	Male – pins 20–14 AWG (0.5–2.5 mm ²)	MS206B	MS210B	MS216B
	Female – sleeves 20–14 AWG (0.5–2.5 mm ²)	FS106B	FS110B	FS116B

Screw terminal wiring adapter blocks

	Screw terminal inserts	6 + G	10 + G	16 + G
	Female insert, ground L. 20–14 AWG (0.5–2.5 mm ²)	FS106WAL	FS110WAL	FS116WAL

01 Use small blade screwdriver to push wire entry tab in for easy contact removal.

Crimp tool

	Cat. no.
	WT611TB

Install to matching series hood/base



Accessories

Cat. no.	Description
WAM-1	Label insert clip
WAM1B	Strip blank
WAM1N64	Strip nos. 1–64
WAM1AZ	Strip letters A–Z

Wiring adapter insert for use with panel bases; allows single access direction panel-build wiring and easy terminal ID for service and testing.

B Series 16 A, 600 V AC

Bases – standard mount				Number of contacts + ground connection								
				6		10		16				
Single lever	Double lever	Housing	NPT entry (in.)		Single		Double		Lever locking type			
			Single	Double	Single	Double	Single	Double				
		Panel base (no cover)	-	PB306**	PB310	PB110E	PB316**	PB116E				
		Panel base (w/cover)	-	PB406**	PB410**	-	PB416**	-				
		Box base (no cover)	1 x ½	BB406MV	BB410MV	BB010EMV	-	-				
			1 x ¾	BB406MVH075	BB410MVH075	BB010MVEH075	BB416MV*	BB016EMV*				
		1 x 1	BB406H100MV	BB410MVH100	BB010EH100MV	BB416H100MV	BB016EH100MV					
		2 x ½	BB506MV	BB510MV	BB110EMV	-	-					
		2 x ¾	BB506H075MV	BB510H075MV	BB110EH075MV	BB516MV*	BB116EMV*					
		Box base (w/cover)	1 x ½	BB606MV**	BB610MV**	-	-	-				
			1 x ¾	BB606H075MV**	BB610H075MV**	-	BB616MV***	-				
		1 x 1	BB606H100**	BB610H100MV**	-	BB616MVH100**	-					
		2 x ½	BB706MV**	BB710MV**	-	-	-					
		2 x ¾	BB706H075**	BB710H075MV**	-	BB716MV***	-					
		2 x 1	BB706H100**	BB710H100MV**	-	BB716H100MV**	-					
Hoods – standard mount *plastic body – “B” 3-16 Series standard hoods include gaskets; bases and special hoods do not.												
		Side entry	1 x ½	SH606MV	SH610MV	SH010MV	-	-				
			1 x ¾	SH606H075MV	SH610H075MV	SH010H075MV	SH616MV†	SH016MV†				
			1 x 1	SH606H100MV	SH610H100MV	SH010H100MV	SH716HMV†	SH116HMV				
		Top entry	1 x ½	TH806MV	TH810MV	TH210MV	-	-				
			1 x ¾	TH806H075MV	TH810H075MV	TH210H075MV	TH816MV†	TH216MV†				
			1 x 1	TH806H100MV	TH810H100MV	TH210H100MV	TH816H100MV	TH316HMV				
Coupler hoods – inline for inline, portable or special service connections. Coupler hoods mate to standard hoods only.												
		Top entry	1 x ½	CH806HMV	CH810EMV	CH610E	-	-				
			1 x ¾	CH806H075MV	CH810H075MV	CH610EH075MV	CH816HMV	CH616EHMV				
			1 x 1	CH806H100MV	CH810H100MV	CH610EH100MV	CH916HMV	CH716EHMV				
Lever hoods – reverse locking lever hoods mate to post bases only.												
		Side entry w/lever(s)	1 x ½	-	-	LH010EMV	-	-				
			1 x ¾	-	-	LH010EH075MV	-	LH016EMV*				
			1 x ¾	-	-	LH010EH100MV	-	LH116EHMV				
		Top entry w/lever(s)	1 x ½	-	-	LH210EMV	-	-				
			1 x ¾	-	-	LH210EH075MV	-	LH216E*				
			1 x 1	-	-	LH210EH100MV	-	LH316EHMV				
Bases – with access cover post bases accept lever hoods only.												
		Panel base + posts w/cover	-	-	-	PB210**	-	PB216**				
				Box base + posts w/cover	1 x ½	-	-	BB210MV**	-	-		
					1 x ¾	-	-	BB210H075MV**	-	BB216MV***		
					1 x 1	-	-	BB210H100MV**	-	BB216H100MV**		
					2 x ½	-	-	BB310MV**	-	-		
					2 x ¾	-	-	BB310H075MV**	-	BB316MV**		
2 x 1	-	-	BB310H100MV**	-	BB316H100MV**							

* High “H” profile may be available. Contact your ABB sales representative.

** Metal “M” cover may be available. Contact your ABB sales representative.

† High “H” and Low “L” profile may be available. Contact your ABB sales representative.

BASES
BASE TO HOOD

HOODS
HOOD TO COUPLER

HOODS
BASE TO HOOD

BASES

HOODS

COUPLER

BASES

Wire pin & sleeve connectors

B Series 16 A, 600 V AC – 24, 32 & 48 contacts + ground



01

Screw terminal inserts

Install to matching series hood/base



	Screw terminal inserts	24 + G	32 + G	48 + G
	Male – Pins 20–14 AWG (0.5–6 mm ²)	MS224B	MS216B (1-16) + MS232B (17-32)	MS224B (1-24) + MS248B (25-48)
	Female – Sleeves 20–14 AWG (0.5–6 mm ²)	FS124B	FS116B (1-16) + FS132B (17-32)	FS124B (1-24) + FS148B (25-48)

Screw terminal wiring adapter blocks

	Screw terminal inserts	24 + G	32 + G	48 + G
	Female insert, ground L 20–14 AWG (0.5–2.5 mm ²)	FS124WAL	–	–

Screw terminal inserts

	Crimp terminal inserts	24 + G	32 + G	48 + G
	Male insert	MC424B	MC416B (1-16) + MC432B (17-32)	MC424B (1-24) + MC448B (25-48)
	Female insert	FC324B	FC316B (1-16) + FC332B (17-32)	FC324B (1-24) + FC348B (25-48)

01 Use small blade screwdriver to push wire entry tab in for easy contact removal.

Crimp tool



Accessories

Cat. no.	Description
WAM-1	Label insert clip
WAM1B	Strip blank
WAM1N64	Strip nos. 1–64
WAM1AZ	Strip letters A–Z
Wiring adapter insert for use with panel bases; allows single access direction panel-build wiring and easy terminal ID for service and testing.	

B Series 16 A, 600 V AC

Bases – standard mount				Number of contacts + ground connection			
				24		32	
Single lever	Double lever	Housing	NPT entry (in)	Lever locking type			
				Single	Double	Double	Single
		Panel base (no cover)	-	PB324	PB124E	PB132	PB348
		Panel base w/cover	-	PB424 [†]	-	-	PB448
		Box base (no cover)	1 x ¾	BB424MV*	BB024EMV*	-	-
			1 x 1	BB424H100MV	BB024EH100MV	BB032MV	BB448MV
			2 x ¾	BB524MV*	BB124EMV*	-	-
			2 x 1	BB524H100MV	BB124EH100MV	BB132MV	BB548MV
		Box base w/cover	1 x ¾	BB624MV* [†]	-	-	-
			1 x 1	BB624H100MV [†]	-	-	BB648MV
			2 x ¾	BB724MV* [†]	-	-	-
			2 x 1	BB724H100MV [†]	-	-	BB748MV
Hoods – standard mount plastic body – “A” 3-16 series standard hoods include gaskets; Bases and special hoods do not							
		Side entry	1 x ¾	SH624MV**	SH024MV**	SH032MV	-
			1 x 1	SH724MV**	SH124MV**	SH132MV	SH648MV
			1 x 1½	-	-	SH132125MV	SH748MV
		Top entry	1 x ¾	TH824MV**	TH224MV**	TH232MV	-
			1 x 1	TH924MV**	TH324MV**	TH332MV	TH848MV
			1 x 1½	-	-	TH332125MV	TH948MV
			Ribbon CBL	-	TH424RCMV	-	-
Coupler hoods – inline – For inline, portable or special service connections. Coupler hoods mate to standard hoods ONLY							
		Top entry	1 x ¾	CH824MV	CH624EMV	CH632MV	-
			1 x 1	CH924MV	CH724EMV	CH732MV	-
			Ribbon CBL	-	CH724ERC MV	-	-
Lever hoods – reverse locking – Lever hoods mate to post bases ONLY							
		Side entry w/lever(s)	1 x ¾	-	LH024EMV	-	-
			1 x 1	-	LH124EMV	-	-
		Top entry w/lever(s)	1 x ¾	-	LH224E	-	-
			1 x 1	-	LH324EMV	-	-
Bases – with access cover post bases accept lever hoods ONLY							
		Panel base w/posts + cover	-	-	PB224 [†]	-	-
		Box base w/posts + cover	1 x ¾	-	BB224MV* [†]	-	-
			1 x 1	-	BB224H100MV	-	-
			2 x ¾	-	BB324MV* [†]	-	-
			2 x 1	-	BB324H100MV	-	-

* High “H” profile may be available. Contact your ABB sales representative.
 ** Low “L” profile may be available. Contact your ABB sales representative.
[†] Metal “M” cover may be available. Contact your ABB sales representative.

BASE TO HOOD

HOOD TO COUPLER

BASE TO HOOD

Wire pin & sleeve connectors

C Series 35 A, 600 V AC – 6 or 12 contacts + ground

Install to matching series hood/base

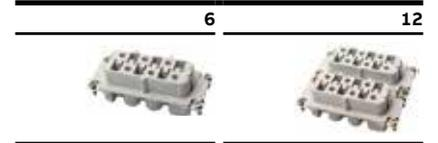

Screw terminal contact carrier connection blocks

	Screw terminal inserts	6 + G	12 + G
	Male – Pins 20–10 AWG (0.5–6 mm ²)	MS206C	MS206C (1–6) + MS212C (7–12)
	Female – Sleeves 20–10 AWG (0.5–6 mm ²)	FS106C	FS106C (1–6) + FS112C (7–12)

C Series 35 A, 600 V AC

		Number of contacts + ground connection				
Bases – standard mount					6	12
Single lever	Double lever	Housing	NPT entry (in.)	Lever locking type		
				Single	Double	Double
		Panel base (no cover)	-	PB316	PB116E	PB132
		Panel base (w/cover)	-	PB416	-	-
		Box base (no cover)	1 x 3/4	BB416MV*	BB016EMV*	-
			1 x 1	BB416H100MV	BB016EH100MV	BB032MV
			2 x 3/4	BB516MV*	BB116EMV*	-
			2 x 1	BB516H100MV	BB116EH100MV	BB132MV
		Box base (w/cover)	1 x 1/2	BB616MV**	-	-
			1 x 1	BB616H100MV†	-	-
			2 x 1/2	BB716MV**	-	-
			2 x 1	BB716H100MV†	-	-
Hoods – standard mount						
		Side entry	1 x 3/4	SH616MV‡	SH016MV‡	SH032MV
			1 x 1	SH716H100MV	SH116H100MV	SH132MV
			1 x 1 1/4	-	-	SH132125MV
		Top entry	1 x 3/4	TH816MV‡	TH216MV‡	TH232MV
			1 x 1	TH816H100MV	TH316H100MV	TH332MV
			1 x 1 1/4	-	-	TH332125MV
Coupler hoods – inline for inline, portable or special service connections. Coupler hoods mate to standard hoods only.						
		Top entry	1 x 3/4	CH816H100MV	CH616EH100MV	CH632MV
			1 x 1	CH916H100MV	CH716EH100MV	CH732MV
Lever hoods – reverse locking lever hoods mate to post bases only.						
		Side entry w/lever(s)	1 x 3/4	-	LH016EMV*	-
			1 x 1	-	LH116EHMV	-
		Top entry w/lever(s)	1 x 3/4	-	LH216E*	-
			1 x 1	-	LH316EHMV	-
Bases – with access cover post bases accept lever hoods only.						
		Panel base + posts w/cover	-	-	PB216†	-
		Box base + posts w/cover	1 x 3/4	-	BB216MV**	-
			1 x 1	-	BB216H100MV†	-
			2 x 3/4	-	BB316MV**	-
			2 x 1	-	BB316H100MV†	-

* High "H" profile may be available. Contact your ABB sales representative.
 ** Low "L" profile may be available. Contact your ABB sales representative.
 † Metal "M" cover may be available. Contact your ABB sales representative.
 ‡ High "H" and Low "L" profile may be available. Contact your ABB sales representative.

Wire pin & sleeve connectors

D Series 10 A, 600 V AC – 7 or 8, 15, 25 & 40 contacts + ground

Install to matching series hood/base



Crimp terminal inserts

	Crimp terminal inserts	7 or 8 + G	15 + G	25 + G	40 + G
	Male insert (Order contacts below)	MC407D or MC408D	MC415D	MC425D	MC440D
	Female insert (Order contacts below)	FC307D or FC308D	FC315D	FC325D	FC340D

Contacts sold separately

Screw terminal wiring adapter blocks

Screw terminal wiring adapter blocks				40 + G
	Male insert, ground L. 26–16 AWG (0.2–1.5 mm ²)	-	-	MS440WAL
	Female insert, ground L. 26–16 AWG (0.2–1.5 mm ²)	-	-	FS340WAL

Contacts selection chart for all crimp terminal “D” inserts

Crimp contacts	Wire AWG (mm ²)	Identification	Female	Male
	22+ AWG (0.14–0.37)	1	FP22SD	MP22SD
	20 AWG (0.5)	2	FP20SD	MP20SD
	18 AWG (0.75–1)	3	FP18SD	MP18SD
	16 AWG (1.5)	4	FP16SD	MP16SD
	14 AWG (2.5)	5	FP14SD	MP14SD

For optic contacts

Crimp contacts	Wire AWG (mm ²)	Identification	Female	Male
	18 AWG (0.75–1)	3	FP18SD	MP18SD

See page 63 for POF installation and tools info.

Accessories

Cat. no.	Description
WAM-1	Label insert clip
WAM1B	Strip blank
WAM1N64	Strip nos. 1–64
WAM1AZ	Strip letters A–Z

Wiring adapter insert for use with panel bases; allows single access direction panel-build wiring and easy terminal ID for service and testing.

Crimp tool

Cat. no.
WT80

Extraction tool

Cat. no.
RT614

D Series 10 A, 600 V AC

Bases – standard mount		Number of contacts + ground connection							
		7 or 8		15	25	40			
Single lever	Double lever	Housing	NPT entry (in.)		Lever locking type				
			Single	Double	Single	Double	Single	Double	
		Panel base (no cover)	–	PB303A(P)**	PB310A	–	–	PB316	PB116E
		Panel base (w/cover)	–	PB403A	PB410A	PB316A	–	PB416	–
		Angled (no cover)	–	PB503A(P)**	PB416A	–	–	–	–
		Box base (no cover)	1 x 3/8	BB403APMV**	–	–	–	–	–
			1 x 1/2	–	BB410AMV	BB416AMV	–	–	–
			2 x 1/2	–	BB510AMV	BB516AMV	–	–	–
			1 x 3/4	–	–	–	–	BB416MV*	BB016EMV*
			1 x 1	–	–	–	–	BB416H100MV	BB016EH100MV
			2 x 3/4	–	–	–	–	BB516MV*	BB116EMV*
			2 x 1	–	–	–	–	BB516H100MV	BB116EH100MV
		Box base (w/cover)	1 x 1/2	–	BB610AMV	BB616AMV	–	–	
			1 x 3/4	–	BB710AMV	BB716AMV	–	–	
			1 x 1	–	–	–	–	BB616MV*†	–
			2 x 1/2	–	–	–	–	BB616H100MV†	–
			2 x 3/4	–	–	–	–	BB716MV*†	–
			2 x 1	–	–	–	–	BB716H100MV†	–
Hoods – standard mount *plastic body – “A” 3-16 series standard hoods include gaskets; bases and special hoods do not.									
		Side entry	1 x 3/8	SH603APMV**	–	–	–	–	
			1 x 1/2	–	SH610AMV	SH616AMV	–	–	
			1 x 3/4	–	SH710AMV	SH716AMV	SH616MV†	SH016MV†	
			1 x 1	–	–	–	SH716H100MV†	SH116H100MV	
		Top entry	1 x 3/8	TH803APMV**	–	–	–	–	
			1 x 1/2	–	TH810AMV	TH816AMV	–	–	
			1 x 3/4	–	TH910AMV	TH916AMV	TH816MV†	TH216MV†	
			1 x 1	–	–	–	TH816H100MV	TH316H100MV	
Coupler hoods – inline for inline, portable or special service connections. Coupler hoods mate to standard hoods only.									
		Top entry	1 x 3/8	CH803APMV**	–	–	–	–	
			1 x 1/2	–	CH810AMV	CH816AMV	–	–	
			1 x 3/4	–	–	–	CH816H100MV	CH616EH100MV	
			1 x 1	–	–	–	CH916H100MV	CH716EH100MV	
Lever hoods – reverse locking lever hoods mate to post bases only.									
		Side entry w/lever(s)	1 x 3/4	–	–	–	–	LH016EMV*	
			1 x 1	–	–	–	–	LH116EH100MV	
		Top entry w/lever(s)	1 x 3/4	–	–	–	–	LH216E*	
			1 x 1	–	–	–	–	LH316EH100MV	
Bases – with access cover post bases accept lever hoods only.									
		Panel base + posts w/cover	–	–	–	–	–	PB216†	
		Box base + posts w/cover	1 x 3/4	–	–	–	–	BB216MV*†	
			1 x 1	–	–	–	–	BB216H100MV†	
			2 x 3/4	–	–	–	–	BB316MV*†	
2 x 1	–		–	–	–	BB316H100MV†			

* High “H” profile may be available. Contact your ABB sales representative.

** Indicates glass-filled thermoplastic construction.

† Metal “M” cover may be available. Contact your ABB sales representative.

‡ High “H” and Low “L” profile may be available. Contact your ABB sales representative.

BASES

BASE TO HOOD

HOODS

HOOD TO COUPLER

COUPLER

HOODS

BASE TO HOOD

BASES

Wire pin & sleeve connectors

D Series 10 A, 600 V AC – 50, 64, 80 & 128 contacts + ground

Install to matching series hood/base

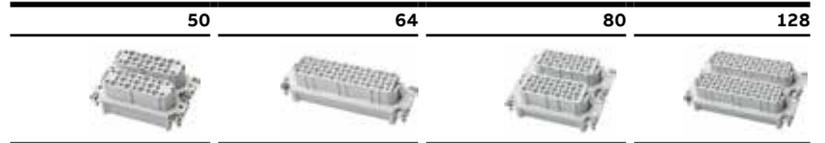

Crimp terminal inserts

	Crimp terminal inserts	50 + G	64 + G	80 + G	128 + G
	Male insert (Order contacts below)	MC425D (2x)	MC464D	MC440D (2x)	MC464D (2x)
	Female insert (Order contacts below)	FC325D (2x)	FC364D	FC340D (2x)	FC364D (2x)

Contacts sold separately

Contacts selection chart for all crimp terminal “D” inserts

Crimp contacts	Wire AWG (mm ²)	Identification	Female	Male
	22+ AWG (0.14–0.37)	1	FP22SD	MP22SD
	20 AWG (0.5)	2	FP20SD	MP20SD
	18 AWG (0.75–1)	3	FP18SD	MP18SD
	16 AWG (1.5)	4	FP16SD	MP16SD
	14 AWG (2.5)	5	FP14SD	MP14SD



Accessories

Cat. no.	Description
MP22SD	Label insert clip
MP20SD	Strip blank
MP18SD	Strip nos. 1–64
MP16SD	Strip letters A–Z

Wiring adapter insert for use with panel bases; allows single access direction panel-build wiring and easy terminal ID for service and testing.

For optic contacts

Crimp contacts	Wire AWG (mm ²)	Identification	Female	Male
	18 AWG (0.75–1)	3	FP18SD	MP18SD

See page 63 for POF installation and tools info.

Crimp tool

Cat. no.
WT80



Extraction tool

Cat. no.
RT614



D Series 10 A, 600 V AC

Bases – standard mount		NPT entry (in.)		Number of contacts + ground connection						
				50	64	16		32		
Single lever	Double lever	Housing	NPT		Lever locking type					
			entry (in.)	Double	Single	Double	Double	Single		
		Panel base (no cover)	-	PB132A	PB324	PB124E	PB132	PB348	BASES	
		Panel base (w/cover)	-	-	PB424	-	-	-		
		Box base (no cover)	1 x ¾	BB032AMV	BB424MV*	BB024EMV*	-	-		
			1 x 1	BB832AMV	BB424H100MV	BB024EH100MV	BB032MV	BB448MV		
			2 x ¾	BB132AMV	BB524MV*	BB124EMV*	-	-		
			2 x 1	BB132A100	BB524H100MV	BB124EH100MV	BB132MV	BB548MV		
		Box base (w/cover)	1 x ¾	-	BB642**	-	-	-		
			1 x 1	-	BB642H100†	-	-	BB648MV		
			2 x ¾	-	BB724MV**	-	-	-		
			2 x 1	-	BB724H100MV†	-	-	BB748MV		
Hoods – standard mount *plastic body – “A” 3-16 series standard hoods include gaskets; bases and special hoods do not.										
		Side entry	1 X ¾	SH032AMV	SH624MV**	SH024MV**	SH032MV	-	HOODS	
			1 X 1	SH132AMV	SH724MV**	SH124MV**	SH132MV	SH648MV		
			1 X 1¼	-	-	-	-	SH748MV		
		Top entry	1 x ¾	TH232AMV	TH824MV**	TH224MV**	TH232MV	-		
			1 x 1	TH332AMV	TH924MV	TH324MV	TH332MV	TH848MV		
			1 X 1¼	-	-	-	-	TH948		
			Ribbon CBL	-	TH624RC	TH424RC	-	-		
Coupler hoods – inline for inline, portable or special service connections. Coupler hoods mate to standard hoods only.										
		Top entry	1 x ¾	-	CH824MV	CH624EMV	CH632MV	-		COUPLER
			1 x 1	-	CH924MV	CH724EMV	CH732MV	-		
			Ribbon CBL	-	-	CH724ERC MV	-	-		
Lever hoods – reverse locking lever hoods mate to post bases only.										
		Side entry w/lever(s)	1 x ¾	LH032AMV	-	LH024EMV	-	-	HOODS	
			1 x 1	LH132AMV	-	LH124EMV	-	-		
		Top entry w/lever(s)	1 x ¾	LH232AMV	-	LH224E	-	-		
			1 x 1	LH332AMV	-	LH324EMV	-	-		
Bases – with access cover post bases accept lever hoods only.										
		Panel base + posts w/cover	-	PB232A	-	PB224†	-	-		BASES
			1 x ¾	BB232AMV	-	BB224MV**	-	-		
		1 x 1	BB232A100MV	-	BB224H100MV	-	-			
		2 x ¾	BB332A	-	BB324MV**	-	-			
		2 x 1	BB332A100	-	BB324H100MV	-	-			

* High “H” profile may be available. Contact your ABB sales representative.

** Low “L” profile may be available. Contact your ABB sales representative.

† Metal “M” cover may be available. Contact your ABB sales representative.

Wire pin & sleeve connectors

DD Series 10 A, 600 V AC – 24, 42 & 72 contacts + ground

Install to matching series hood/base



Crimp terminal inserts

	Screw terminal inserts	24 + G	42 + G	72 + G
	Male insert (Order contacts below)	MC224DD	MC242DD	MC272DD
	Female insert (Order contacts below)	FC124DD	FC142DD	FC172DD

Contacts selection chart for all crimp terminal “DD” inserts

Crimp contacts	Wire AWG (mm ²)	Identification	Female	Male
	22+ AWG (0.14–0.37)	1	FP22SD	MP22SD
	20 AWG (0.5)	2	FP20SD	MP20SD
	18 AWG (0.75–1)	3	FP18SD	MP18SD
	16 AWG (1.5)	4	FP16SD	MP16SD
	14 AWG (2.5)	5	FP14SD	MP14SD

See page 63 for POF installation and tools info.

Crimp tool

	Cat. no.
	WT80

Extraction tool

	Cat. no.
	RT614

DD Series 10 A, 600 V AC

Bases – standard mount				Number of contacts + ground connection				
				24		42		72
Single lever	Double lever	Housing entry (in.)	NPT	Lever locking type				
				Single	Single	Double	Single	Double
		Panel base (no cover)	–	PB306**	PB310**	PB110E	PB316	PB116E
		Panel base (w/cover)	–	PB406**	PB410**	–	PB416	–
		Box base (no cover)	1 x ½	BB406MV	BB410MV	BB010EMV	–	–
			1 x ¾	BB406MVH075	BB410H075MV	BB010EH075MV	BB416MV*	BB016EMV*
			1 x 1	BB406H100MV	BB410H100MV	BB010EH100MV	BB416H100MV	BB016EH100MV
			2 x ½	BB506MV	BB510MV	BB110EMV	–	–
			2 x ¾	BB506H075MV	BB510H075MV	BB110EH075MV	BB516MV*	BB116EMV*
			2 x 1	BB506H100	BB510H100	BB110EH100MV	BB516H100MV	BB116EH100MV
		Box base	1 x ½	BB606MV**	BB610MV**	–	–	–
			1 x ¾	BB606H075MV**	BB610H075MV**	–	BB616MV* **	–
			1 x 1	BB606H100**	BB610H100MV**	–	BB616H100MV**	–
			2 x ½	BB706MV**	BB710MV**	–	–	–
			2 x ¾	BB706H075**	BB710H075MV**	–	BB716MV* **	–
			2 x 1	BB706H100**	BB710H100MV**	–	BB716H100MV**	–
Hoods – standard mount								
		Side entry	1 x ½	SH606MV	SH610MV	SH010MV	–	–
			1 x ¾	SH606H075MV	SH610H075MV	SH010H075MV	SH616MV†	SH016MV†
			1 x 1	SH606H100MV	SH610H100MV	SH010H100MV	SH716H100MV†	SH116H100MV
		Top entry	1 x ½	TH806MV	TH810MV	TH210MV	–	–
			1 x ¾	TH806H075MV	TH810H075MV	TH210H075MV	TH816MV†	TH216MV†
			1 x 1	TH806H100MV	TH810H100MV	TH210H100MV	TH816H100MV	TH316H100MV
Coupler hoods – inline for inline, portable or special service connections. Coupler hoods mate to standard hoods only.								
		Top entry w/leveler(s)	1 x ½	CH806	CH810	CH610E	–	–
			1 x ¾	CH806H075MV	CH810H075MV	CH610EH075MV	CH816H100MV	CH616EH100MV
			1 x 1	CH806H100MV	CH810H100MV	CH610EH100MV	CH916H100MV	CH716EH100MV
Lever hoods – reverse locking lever hoods mate to post bases only.								
		Side entry w/lever(s)	1 x ½	–	–	LH010EMV	–	–
			1 x ¾	–	–	LH010EH075MV	–	LH016EMV*
			1 x 1	–	–	LH010EH100MV	–	LH116EHMV
		Top entry w/lever(s)	1 x ½	–	–	LH210EMV	–	–
			1 x ¾	–	–	LH210EH075MV	–	LH216E*
			1 x 1	–	–	LH210EH100MV	–	LH316EHMV
Bases – with access cover post bases accept lever hoods only.								
		Panel + posts w/cover	–	–	–	PB210**	–	PB216**
		Box + posts w/cover	1 x ½	–	–	BB210MV**	–	–
			1 x ¾	–	–	BB210H075MV**	–	BB216MV* **
			1 x 1	–	–	BB210H100MV**	–	BB216H100MV**
			2 x ½	–	–	BB310MV**	–	–
			2 x ¾	–	–	BB310H075MV**	–	BB316MV* **
			2 x 1	–	–	BB310H100MV**	–	BB316H100MV**

* High "H" profile may be available. Contact your ABB sales representative.

** Metal "M" cover may be available. Contact your ABB sales representative.

† High "H" and Low "L" profile may be available. Contact your ABB sales representative.

BASE TO HOOD

HOOD TO COUPLER

BASE TO HOOD

Wire pin & sleeve connectors

DD Series 10 A, 600 V AC – 108, 144 & 216 contacts + ground

Install to matching series hood/base

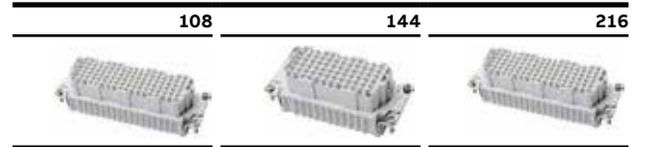

Crimp terminal inserts

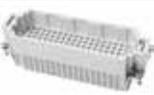
	Crimp terminal inserts	108 + G	144 + G	216 + G
	Male insert (Order contacts below)	MC208DD	MC272DD+ MC244DD	MC208DD+ MC216DD
	Female insert (Order contacts below)	FC108DD	FC172DD+ FC144DD	FC108DD+ FC116DD

Contacts selection for all crimp terminal “DD” inserts

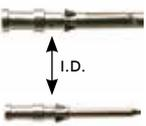
Crimp contacts	Wire gauge AWG (mm ²)	Identification	Female	Male
	22+ AWG (0.14–0.37)	1	FP22SD	MP22SD
	20 AWG (0.5)	2	FP20SD	MP20SD
	18 AWG (0.75–1)	3	FP18SD	MP18SD
	16 AWG (1.5)	4	FP16SD	MP16SD
	14 AWG (2.5)	5	FP14SD	MP14SD

See page 63 for POF installation and tools info.

Crimp tool

	Cat. no.
	WT80

Extraction tool

	Cat. no.
	RT614

DD Series 10 A, 600 V AC

			Number of contacts + ground connection				
Bases – standard mount			108	144	216		
Single lever	Double lever	Housing	NPT entry (in.)	Lever locking type			
				Single	Double	Double	Single
		Panel base (no cover)	-	PB324	PB124E	PB132	PB348
		Panel base (w/cover)	-	PB424 [†]	-	-	PB448
		Box base (no cover)	1 x ¾	BB424MV*	BB024EMV*	-	-
			1 x 1	BB424H100MV	BB024EH100MV	BB032MV	BB448MV
		2 x ¾	BB524MV*	BB124EMV*	-	-	
		2 x 1	BB524H100MV	BB124EH100MV	BB132MV	BB548MV	
		Box base (w/cover)	1 x ¾	BB624MV** [†]	-	-	-
			1 x 1	BB624H100MV [†]	-	-	BB648MV
		2 x ¾	BB724MV** [†]	-	-	-	
		2 x 1	BB724H100MV [†]	-	-	BB748MV	
Hoods – standard mount							
		Side entry	1 x ¾	SH624MV**	SH024MV**	SH032MV	-
			1 x 1	SH724MV**	SH124MV**	SH132MV	SH648MV
			1 x 1 ¼	-	-	SH132125MV	SH748MV
		Top entry	1 x ¾	TH824MV**	TH224MV**	TH232MV	-
			1 x 1	TH924MV**	TH324MV**	TH332MV	TH848MV
			1 x 1 ¼	-	-	TH332125MV	TH948MV
Coupler hoods – inline for inline, portable or special service connections. Coupler hoods mate to standard hoods only.							
		Top entry	1 x ¾	CH824MV	CH624EMV	CH632MV	-
			1 x 1	CH924MV	CH724EMV	CH732MV	-
Lever hoods – reverse locking lever hoods mate to post bases only.							
		Side entry w/lever(s)	1 x ¾	-	LH024EMV	-	-
			1 x 1	-	LH124EMV	-	-
		Top entry w/lever(s)	1 x ¾	-	LH224E	-	-
			1 x 1	-	LH324EMV	-	-
Bases – with access cover post bases accept lever hoods only.							
		Panel base w/posts + cover	-	-	PB224 [†]	-	-
			Box base w/posts + cover	1 x ¾	-	BB224MV** [†]	-
		1 x 1	-	BB224H100MV	-	-	
		2 x ¾	-	BB324MV** [†]	-	-	
			2 x 1	-	BB324H100MV	-	-

* High "H" profile may be available. Contact your ABB sales representative.
 ** Low "L" profile may be available. Contact your ABB sales representative.
[†] Metal "M" cover may be available. Contact your ABB sales representative.

Wire pin & sleeve connectors

K Series 80 + 16 A, 600 V AC – 4 @ 80A + 8 @ 16A, 8 @ 80A + 16 @ 16A contacts + ground

Install to matching series hood/base

4 @ 80 A + 8 @ 16 A + G

8 @ 80 A + 16 @ 16 A + G



Screw terminal contact carrier inserts

Screw terminal contact carrier inserts	4 @ 80 A+8 @ 16 A+G	8 @ 80 A+16 @ 16 A+G
 <p>Male – Pins</p>	MS212K	MS212K (x2)
 <p>Female – Sleeves</p>	FS112K	FS112K (x2)

Wiring note: To #6 AWG (16 mm²) 80 A contacts and to #14 AWG (2.5 mm²) 16 A contacts.

K Series 80 + 16 A, 600 V AC

				Number of contacts + ground connection		
				K-12	K-24	
Bases – standard mount				4 @ 80 A + 8 @ 16 A + G	8 @ 80 A + 16 @ 16 A + G	
Single lever	Double lever	Housing	NPT entry (in.)	Single	Double	Single
				Lever locking type		
		Panel base (no cover)	–	PB324	PB124E	PB348
		Panel base (w/cover)	–	PB424	–	–
		Box base (no cover)	1 x ¾	BB424MV*	BB024EMV	–
			1 x 1	BB424H100MV	BB024EH100MV	BB448MV
			2 x ¾	BB524MV*	BB124EMV*	–
			2 x 1	BB524H100MV	BB124EH100MV	BB548MV
		Box base (w/cover)	1 x ¾	BB624MV†	–	–
			1 x 1	BB624H100MV†	–	BB648MV
			2 x ¾	BB724MV*‡	–	–
			2 x 1	BB724H100MV†	–	BB748MV
Hoods – standard mount *plastic body – “A” 3-16 Series standard hoods include gaskets; bases and special hoods do not.						
		Side entry	1 x ¾	SH624MV**	SH024MV**	–
			1 x 1	SH724MV**	SH124MV**	SH648MV
			1 x 1½	–	–	SH748MV
		Top entry	1 x ¾	TH824MV**	TH224MV**	–
			1 x 1	TH924MV	TH324MV	TH848MV
			1 x 1½	–	–	TH948MV
Coupler hoods – inline for inline, portable or special service connections. Coupler hoods mate to standard hoods only.						
		Top entry	1 x ¾	CH824MV	CH624EMV	–
			1 x 1	CH924MV	CH724EMV	–
Lever hoods – reverse locking lever hoods mate to post bases only.						
		Side entry w/lever(s)	1 x ¾	–	LH032AMV	–
			1 x 1	–	LH132AMV	–
		Top entry w/lever(s)	1 x ¾	–	LH232AMV	–
			1 x 1	–	LH332AMV	–
Bases – with access cover post bases accept lever hoods only.						
		Panel base + posts w/cover	–	–	PB224†	–
		Box base + posts w/cover	1 x ¾	–	BB224MV**	–
			2 x ¾	–	BB324MV**	–

* High “H” profile may be available. Contact your ABB sales representative.

** Low “L” profile may be available. Contact your ABB sales representative.

† Metal “M” cover may be available. Contact your ABB sales representative.

Wire pin & sleeve connectors

V Series 16 A, 600 V AC – 3 & 6 contacts + control contacts & ground



01

Install to matching series hood/base



Screw terminal inserts

	Screw terminal inserts (mm ²)	3 + G + 2 control	6 + G + 2 control
	Male - Pins 20-14 AWG (0.5-2.5)	MS203V	MS206V
	Female - Sleeves 20-14 AWG (0.5-2.5)	FS103V	FS106V

01 Use small blade screwdriver to push wire entry tab in for easy contact removal.

Crimp tool



V Series 16 A, 600 V AC

Hoods – standard mount			Number of contacts + ground connection				
			3 + G + 2 control		6 + G + 2 control		
Single lever	Double lever	Housing	NPT entry (in.)	Lever locking type		Single	Double
				Single	Double		
		Side entry	1 x ½	SH603V	SH003V	-	-
			1 x ¾	-	-	SH606VMV	SH006V
		Top entry	1 x ½	TH803VMV	TH203V	-	-
			1 x ¾	-	-	TH806VMV	TH206V

HOODS

* Metal "M" cover may be available. Contact your ABB sales representative.

Wire pin & sleeve connectors

V Series 16 A, 600 V AC – 20, 26 & 32 contacts + 2 control contacts & ground



01

Install to matching series hood/base



Screw terminal inserts

	Screw terminal inserts (mm ²)	20 + G + 2 control	26 + G + 2 control	32 + G + 2 control
	Male - Pins 20–14 AWG (0.5–2.5)	MS210V	MS210V + MS216V	2x MS216V
	Female - Sleeves 20–14 AWG (0.5–2.5)	FS110V	FS110V + FS116V	2x FS116V

01 Use small blade screwdriver to push wire entry tab in for easy contact removal.

Crimp tool



V Series 16 A, 600 V AC

		Number of contacts + ground connection	
		V20: (20 + G) or (26 + G) or (32 + G) + 2 Control	
Double lever	Housing	NPT entry (in.)	Lever locking type
			Single
	Panel base (no cover)	-	PB348
	Panel base (w/cover)	-	PB448
	Box base (no cover)	1 x 3/4	-
		1 x 1	BB448MV
		2 x 3/4	-
		2 x 1	BB548MV
	Box base (no cover)	1 x 3/4	-
		1 x 1	BB648MV
		2 x 3/4	-
		2 x 1	BB748MV
Hoods – standard mount *Plastic body – “A” 3-16 Series standard hoods include gaskets; bases and special hoods do not.			
	Side entry	1 x 3/4	-
		1 x 1	SH648MV
		1 x 1 1/4	SH748MV
	Top entry	1 x 3/4	-
		1 x 1	TH848MV
		1 x 1 1/4	TH948MV

BASES

BASE TO HOOD

HOODS

¹ Metal “M” cover may be available. Contact your ABB sales representative.
 * Indicates glass-filled thermoplastic construction, black colour (add suffix); quantity purchase may be required.

Wire pin & sleeve connectors

T Series 16 A, 600 V AC – 6, 10, 16 & 24 contacts + ground

- High-temp 200 °C rated inserts
- Silicone Viton® seals for molded-edge gaskets*
- Corrosion-resistant copper-free aluminum housings with special finish
- UL94V-O ergonomic thermoplastic handles
- Electrostatic epoxy powder-coated finish

*Viton is a trademark of DuPont Performance Elastomers.

Install to matching series hood/base

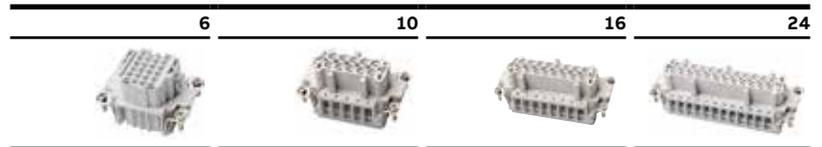

Screw terminal inserts

	Screw terminal inserts* (mm²)	6 + G	10 + G	16 + G	24 + G
	Male – Pins 20–14 AWG (0.5–2.5)	MS206T	MS210T	MS216T	MS224T
	Female – Sleeve 20–14 AWG (0.5–2.5)	FS106T	FS110T	FS116T	FS124T

* Inserts may be dark brown or gray in color.

T Series 16 A, 600 V AC

Bases – standard mount		Housing		Number of contacts + ground connection				Lever locking type	
				6	10	16	24		
Single lever	Double lever		NPT entry (in.)	Single	Double	Double	Double		
		Panel base	–	PB306T	PB110T	PB116T	PB124T	BASES	
		Box base (no cover)	1 x ½	BB406TMV	BB010TMV	–	–		
			1 x ¾	–	–	BB016TMV	BB024TMV		
			2 x ½	BB506TMV	BB110TMV	–	–		
			2 x ¾	–	–	BB116TMV	BB124TMV		
Hoods – standard mount									
		Side entry	1 x ½	SH606T	SH010TMV	–	–	HOODS	
			1 x ¾	–	–	SH016TMV	SH024TMV		
			1 x 1	–	–	–	SH124TMV		
		Top entry	1 x ½	TH806T	TH210T	–	–	HOODS	
			1 x ¾	–	–	TH216T	TH224T		
			1 x 1	–	–	–	TH324TMV		
Coupler hoods – inline for inline, portable or special service connections. Coupler hoods mate to standard hoods only.									
		Top entry	1 x ½	CH806T	CH610T	–	–	COUPLER	
			1 x ¾	–	–	CH616TMV	CH624T		
			1 x 1	–	–	CH716T	CH724T		

Note: Hoods and Bases are black colored to denote special T series.

Technical information

A Series

Specifications

- DIN VDE 0627/86
- DIN VDE 0627/86
- DIN VDE 0110/02.79
- DIN VDE 0110/02.79
- DIN VDE 0110-1/04.97
- DIN VDE 0110-1/04.97
- IEC 60-664-1, DIN/IEC 512
- IEC 60-664-1, DIN/IEC 512

Approvals

- MEIE, EZU, SEV
- 

Inserts

- Contacts (+ ground)
 - 3, 4, 10, 16, 32 (2 x 16)
- Working current
 - A3, A4 @ 10 A max.
 - A10–A32 @ 16 A max.
- Rated voltage
 - 600 V AC
- Test voltage
 - 4 kV eff.
- Pollution degree
 - 3
- Material
 - Glass-filled thermoplastic
- Temperature range
 - -40 °C/-40 °F to +125 °C/+257 °F
- Flammability
 - UL94 V-0

Contacts

- Material
 - Solid drilled copper alloy
- Surface
 - Hard silver plated
 - Hard gold plated available
- Contact resistance
 - ≤ 1 milliohm
- Screw terminals
 - Wire AWG
- + with wire protection
 - 20–14 AWG (0.5–2.5 mm²)
- Crimp terminals
 - 20–12 AWG (0.5–2.5 mm²)

Housings

- Materials
 - Die-cast aluminum alloy
- EPDM seal gaskets
 - Epoxy powder-coat finish
- Locking mechanisms
 - @ A3, 4, 10, 16
- Temperature range
 - -40 °C/-40 °F to +125 °C/+257 °F
- Internal protection
 - A3, 4: IP44
 - A10, 16, 32: IP65 per DIN VDE 0470, IEC 529

Thermal capacity

- per DIN/IEC 512

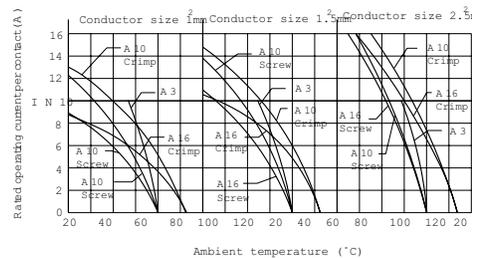

Technical information

B Series

Specifications

- DIN VDE 0627/86
- DDIN VDE 0110/02.79
- DIN VDE 0110-1/04.97
- IEC 60-664-1, DIN/IEC 512

Approvals

- MEIE, EZU, SEV
- 

Inserts

- Contacts (+ ground)
 - 6, 10, 16, 24, 32 (2 x 16), 48 (2 x 24)
- Working current
 - 16 A max.
- Rated voltage
 - 600 V AC
- Test voltage
 - 3 kV eff.
- Pollution degree
 - 3
- Material
 - Glass-filled thermoplastic
- Temperature range
 - -40 °C/-40 °F to +125 °C/+257 °F
- Flammability
 - UL94 V-0

Contacts

- Material
 - Solid drilled copper alloy
- Surface
 - Hard silver plated
 - Hard gold plated available
- Contact resistance
 - ≤ 1 milliohm
- Screw terminals
 - Wire AWG
- + with wire protection
 - 20–14 AWG (0.5–2.5 mm²)
- Crimp terminals
 - 20–12 AWG (0.5–2.5 mm²)

Housings

- Materials
 - Die-cast aluminum alloy
- EPDM seal gaskets
 - Epoxy powder-coat finish
- Temperature range
 - -40 °C/-40 °F to +125 °C/+257 °F
- Internal protection
 - IP65 locked positions
 - per DIN VDE 0470, IEC 529

Thermal capacity

- per DIN/IEC 512

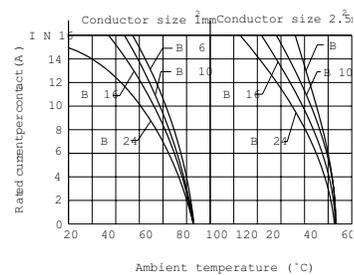

Technical information

C Series

Specifications

- DIN VDE 0627/86
- DIN VDE 0627/86
- DIN VDE 0110/02.79
- DIN VDE 0110/02.79
- DIN VDE 0110-1/04.97
- DIN VDE 0110-1/04.97
- IEC 60-664-1, DIN/IEC 512
- IEC 60-664-1, DIN/IEC 512

Approvals

- MEIE, EZU, SEV
- 

Inserts

- Contacts (+ ground)
 - 6, 12 (2 x 6)
- Working current
 - 35 A
- Rated voltage
 - 600 V AC
- Test voltage
 - 3 kV eff.
- Pollution degree
 - 3
- Material
 - Glass-filled thermoplastic
- Temperature range
 - -40 °C/-40 °F to +125 °C/+257 °F
- Flammability
 - UL94 V-0

Contacts

- Material
 - Solid drilled copper alloy
- Surface
 - Hard silver plated
 - Hard gold plated available
- Contact resistance
 - ≤ 0.5 milliohm
- Screw terminals
 - Wire AWG
- + with wire protection
 - 20–10 AWG (0.5–6.0 mm²)
- + w/o wire protection
 - n/a

Housings

- Materials
 - Die-cast aluminum alloy
- EPDM seal gaskets
 - Epoxy powder-coat finish
- Temperature range
 - -40 °C/-40 °F to +125 °C/+257 °F
- Internal protection
 - IP65 locked positions
 - per DIN VDE 0470, IEC 529

Thermal capacity

- per DIN/IEC 512

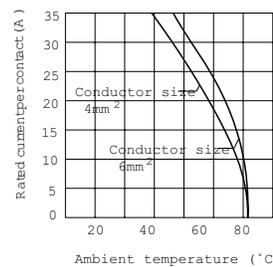

Technical information

D Series

Specifications

- DIN VDE 0627/86
- DIN 43652
- DDIN VDE 0110/02.79
- DIN VDE 0110-1/04.97
- IEC 60-664-1, DIN/IEC 512

Approvals

- MEIE, EZU, SEV
- 

Inserts

- Contacts (+ ground)
 - 7, 8, 15, 25, 40, 50 (2 x 25)
 - 64, 80 (2 x 40), 128 (2 x 64)
- Working current
 - 10 A
- Rated voltage
 - 600 V AC
- Test voltage
 - 4 kV eff.
- Pollution degree
 - 3
- Material
 - Glass-filled thermoplastic
- Temperature range
 - -40 °C/-40 °F to +125 °C/+257 °F
- Flammability
 - UL94 V-0

Contacts

- Material
 - Solid drilled copper alloy
- Surface
 - Hard silver plated
 - Hard gold plated available
- Contact resistance
 - ≤ 3 milliohm
- Crimp terminals
 - Wire AWG
 - 26–14 AWG (.142–2.5 mm²)
- > Glass fiber optic cable
 - POF {0} 1 mm

Housings

- Materials
 - Die-cast aluminum alloy
- EPDM seal gaskets
 - Epoxy powder-coat finish
- Temperature range
 - -40 °C/-40 °F to +125 °C/+257 °F
- Internal protection
 - IP65 locked positions
 - per DIN VDE 0470, IEC 529
- Thermal capacity
 - per DIN/IEC 512

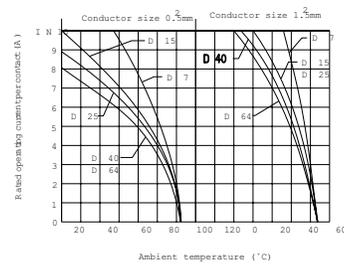

Technical information

DD Series

Specifications

- DIN VDE 0627/86
- DIN VDE 0110/02.79
- DIN VDE 0110-1/04.97
- IEC 60-664-1, DIN/IEC 512

Approvals

- MEIE, EZU, SEV
- 

Inserts

- Contacts (+ ground)
 - 24, 42, 72, 108, 144 (2 x 72)
- Working current
 - 216 (2 x 108)
 - 10 A
- Rated voltage
 - 600 V AC
- Test voltage
 - 2 kV eff.
- Pollution degree
 - 3
- Material
 - Glass-filled thermoplastic
- Temperature range
 - -40 °C/-40 °F to +125 °C/+257 °F
- Flammability
 - UL94 V-0

Contacts

- Material
 - Solid drilled copper alloy
- Surface
 - Hard silver plated
 - Hard gold plated available
- Contact resistance
 - ≤ 3 milliohm
- Crimp terminals
 - Wire AWG
 - 26–14 AWG (.14–2.5 mm²)
- > Glass fiber optic cable
 - POF {0} 1 mm

Housings

- Materials
 - Die-cast aluminum alloy
- EPDM seal gaskets
 - Epoxy powder-coat finish
- Temperature range
 - -40 °C/-40 °F to +125 °C/+257 °F
- Internal protection
 - IP65 locked positions
 - per DIN VDE 0470, IEC 529

Thermal capacity

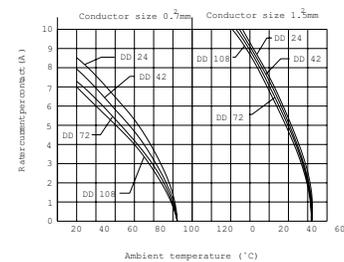

Technical information

K Series

Specifications

- DIN VDE 0627/86
- VDE 0113/1.73-10.1.3
- DDIN VDE 0110/4
- VDE 0100/5.73-42a
- IEC 60-664-1, DIN/IEC 512

Approvals

- MEIE, EZU, SEV



Inserts

- Contacts (+ ground)
 - 8 (16 A) + 4 (80 A)
 - 16 (16 A) + 8 (80 A)
- Working current
 - 16 A and 80 A dual
- Rated voltage
 - 600 V AC
- Test voltage
 - 2 kV eff.
- Pollution degree
 - 3
- Material
 - Glass-filled thermoplastic
- Temperature range
 - -40 °C/-40 °F to +125 °C/+257 °F
- Flammability
 - UL94 V-0

Contacts

- Material
 - Solid drilled copper alloy
- Surface
 - Hard silver plated
- Hard gold plated available
- Contact resistance
 - ≤ 1 milliohm
- Screw terminals
 - Wire AWG
- + with wire protection (16 A)
 - 20–14 AWG (0.5–2.5 mm²)
- (80 A contacts)
 - 18–4 AWG (1.5–16.0 mm²)

Housings

- Materials
 - Die-cast aluminum alloy
- EPDM seal gaskets
 - Epoxy powder-coat finish
- Temperature range
 - -40 °C/-40 °F to +125 °C/+257 °F
- Internal protection
 - IP65 locked positions
 - per DIN VDE 0470, IEC 529

Technical information

V Series

Specifications

- DIN VDE 0627/86
- DIN VDE 0110/02.79
- DIN VDE 0110-1/04.97
- IEC 60-664-1, DIN/IEC 512

Approvals

- MEIE, EZU, SEV
- 

Inserts

- Contacts (+ ground)
 - 3, 6, 10, 16, 20 (2 x 10)
 - 26 (10+16), 32 (2 x 16)
- Working current
 - 16 A max.
- Rated voltage
 - 600 V AC; switch contacts 400 V AC
- Test voltage
 - 3 kV eff.
- Pollution degree
 - 3
- Material
 - Glass-filled thermoplastic
- Temperature range
 - -40 °C/-40 °F to +125 °C/+257 °F
- Flammability
 - UL94 V-0

Contacts

- Material
 - Solid drilled copper alloy
- Surface
 - Hard silver plated
 - Hard gold plated available
- Contact resistance
 - ≤ 1 milliohm
- Screw terminals
 - Wire AWG
- + with wire protection
 - 20–14 AWG (0.5–2.5 mm²)
- Crimp terminals
 - 20–12 AWG (0.5–2.5 mm²)

Housings

- Materials
 - Die-cast aluminum alloy
- EPDM seal gaskets
 - Epoxy powder-coat finish
- Temperature range
 - -40 °C/-40 °F to +125 °C/+257 °F
- Internal protection
 - IP65 locked positions
 - per DIN VDE 0470, IEC 529

Thermal capacity

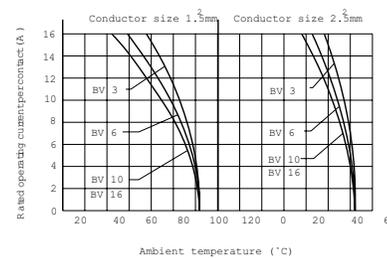

Technical information

T Series

Specifications

- DIN VDE 0627/86
- DDIN VDE 0110/02.79
- DIN VDE 0110-1/04.97
- IEC 60-664-1, DIN/IEC 512

Approvals

- MEIE, EZU, SEV
- 

Inserts

- Contacts (+ ground)
 - 6, 10, 16, 24
- Working current
 - 16 A max.
- Rated voltage
 - 600 V AC; switch contacts 400 V AC
- Test voltage
 - 3 kV eff.
- Pollution degree
 - 3
- Material
 - Hi-temp thermoplastic
- Temperature range
 - -40 °C/-40 °F to +200 °C/+392 °F
- Flammability
 - UL94 V-0

Contacts

- Material
 - Solid drilled copper alloy
- Surface
 - Hard silver plated
 - Hard gold plated available
- Contact resistance
 - ≤ 1 milliohm
- Screw terminals
 - Wire AWG
- + with wire protection
 - 20–14 AWG (0.5–2.5 mm²)

Housings

- Materials
 - Copper-free die-cast aluminum alloy
- Viton® seal gaskets
 - Green epoxy powder coating
- Temperature range
 - -40 °C/-40 °F to +200 °C/+392 °F
- Internal protection
 - IP65 locked positions
 - per DIN VDE 0470, IEC 529

Thermal capacity

- per DIN/IEC 512

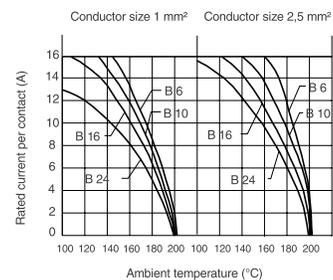

Technical information

Mounting dimensions for lever box bases

Mounting dimensions for double lever box bases

Housing series					Dimensions are in inches/(millimeters)						
A, B, T, K	C, V	D	DD	Cat. no.	A	B	C	D	E	F	G
A32	D50	-	-	BB_32A__	3.70/(94)	4.17/(106)	5.04/(128)	1.81/(46)	2.20/(56)	2.76/(70)	3.40/(86.5)
B10, T10	V3	-	DD42	BB_10E	3.23/(82)	3.66/(93)	4.33/(110)	1.57/(40)	2.05/(52)	2.28/(58)	2.05/(52)
				BB_10EH__	3.23/(82)	3.66/(93)	4.33/(110)	1.77/(45)	2.24/(57)	2.28/(58)	2.92/(74)
B16, T16	C6, V6	D40	DD72	BB_16E	4.13/(105)	4.61/(117)	5.16/(131)	1.77/(45)	2.24/(57)	2.28/(58)	2.68/(68)
				BB_16EH__	4.13/(105)	4.61/(117)	5.16/(131)	1.77/(45)	2.24/(57)	2.28/(58)	3.31/(84)
B24, T24, K12	V10, V16	D64	DD108	BB_24E	5.20/(132)	5.67/(144)	6.18/(157)	1.77/(45)	2.24/(57)	2.28/(58)	2.68/(68)
				BB_24EH__	5.20/(132)	5.67/(144)	6.18/(157)	1.77/(45)	2.24/(57)	2.28/(58)	3.31/(84)
B32	C12	D80	DD144	BB_32E	4.41/(112)	4.88/(112)	5.28/(134)	2.64/(67)	3.20/(81.5)	3.62/(92)	2.83/(72)

Dimensions

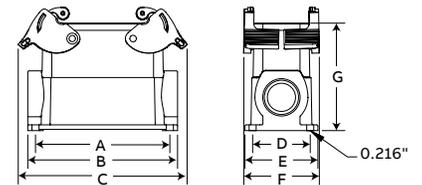

Mounting dimensions for single lever box bases

Housing series					Dimensions are in inches/(millimeters)						
A, B, T, K	C, V	D	DD	Cat. no.	A	B	C	D	E	F	G
A3, A4	-	D7, D8	-	BB403A(P)*	1.10/(28)	1.59/(40.5)	1.00/(25.5)	1.42/(36)	1.18/(30)	1.50/(38)	-
A10	-	D15	-	BB_10A	1.89/(48)	-	3.66/(93)	1.57/(40)	1.97/(50)	2.32/(59)	2.05/(52)
A16	-	D25	-	BB_16A	2.52/(64)	-	4.29/(109)	1.57/(40)	1.97/(50)	2.32/(59)	2.24/(57)
B6, T6	-	-	DD24	BB_06	2.76/(70)	3.31/(84)	-	1.57/(40)	2.05/(52)	2.72/(69)	2.05/(52)
				BB_06H075	2.76/(70)	3.31/(84)	-	1.77/(45)	2.24/(57)	2.72/(69)	2.92/(74)
				BB_06H100	2.76/(70)	3.31/(84)	-	1.77/(45)	2.24/(57)	2.72/(69)	2.92/(74)
B10, T10	V3	-	DD42	BB_10	3.23/(82)	3.66/(93)	-	1.57/(40)	2.05/(52)	2.80/(71)	2.05/(52)
				BB_10H075	3.23/(82)	3.66/(93)	-	1.77/(45)	2.24/(57)	2.80/(71)	2.92/(74)
				BB_10H100	3.23/(82)	3.66/(93)	-	1.77/(45)	2.24/(57)	2.80/(71)	2.92/(74)
B16, T16	C6, V6	D40	DD72	BB_16	4.13/(105)	4.61/(117)	-	1.77/(45)	2.24/(57)	2.91/(74)	2.68/(68)
				BB_16H___	4.13/(105)	4.61/(117)	-	1.77/(45)	2.24/(57)	2.91/(74)	3.31/(84)
B24, T24, K12	V10, V16	D64	DD108	BB_24	5.20/(132)	5.67/(144)	-	1.77/(45)	2.24/(57)	2.91/(74)	2.68/(68)
				BB_24H___	5.20/(132)	5.67/(144)	-	1.77/(45)	2.24/(57)	2.91/(74)	3.31/(84)
B48, K24, V32	V20, V26	D128	DD216	BB_48	4.37/(111)	5.71/(145)	-	4.17/(106)	4.72/(120)	6.18/(157)	3.94/(100)

Dimensions
Right angle housing
A3/A4
D7/D8
only

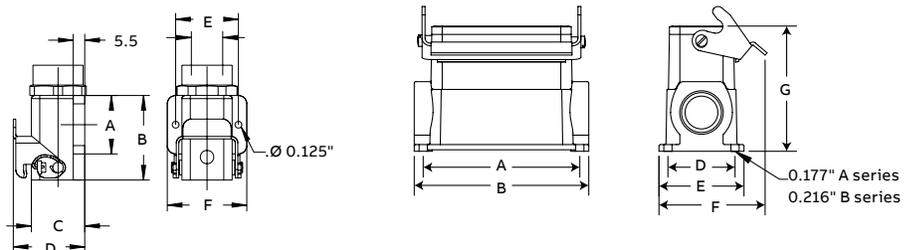

* Suffix: A – Aluminum, P – Plastic.

Technical information

Mounting dimensions for lever panel bases

Mounting dimensions for double lever panel bases

Housing series				Dimensions are in inches/(millimeters)							
A, B, T, K	C, V	D	DD	Cat. no.	A	B	C	D	E	F	G
A32	D50	-	-	PB132A	3.62/(92)	4.02/(102)	5.04/(128)	1.65/(28)	2.24/(57)	2.76/(70)	1.10/(28)
B10, T10	V3	-	DD42	PB110E	3.27/(83)	3.66/(93)	4.33/(110)	1.26/(32)	1.69/(43)	2.28/(58)	1.06/(27)
B16, T16	C6, V6	D40	DD72	PB116E	4.05/(103)	4.49/(114)	5.16/(131)	1.26/(32)	1.69/(43)	2.28/(58)	1.06/(27)
B24, T24, K12	V10, V16	D64	DD108	PB124E	5.12/(130)	5.51/(140)	6.19/(157)	1.26/(32)	1.69/(43)	2.28/(58)	1.06/(27)
B32	C12	D80	DD144	PB132E	4.33/(110)	4.88/(124)	5.28/(134)	2.56/(65)	3.11/(79)	3.62/(92)	1.18/(30)

Dimensions

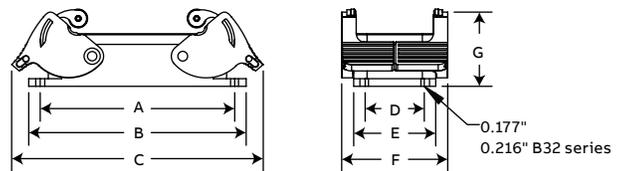

Mounting dimensions for single lever panel bases

Housing series				Dimensions are in inches/(millimeters)							
A, B, T, K	C, V	D	DD	Cat. no.	A	B	C	D	E	F	G
A3, A4	-	D7, D8	-	PB303A (P)*	-	1.10/(28)	1.34/(34)	1.18/(30)	1.50/(38)	1.67/(42.5)	0.95/(24)
				PB403A (P)*	-	1.10/(28)	1.38/(35)	1.18/(30)	1.58/(40)	1.85/(47)	0.95/(24)
				PB503A (P)	1.10/(28)	1.59/(40.5)	1.00/(25.5)	1.42/(36)	1.18/(30)	1.50/(38)	-
A10	-	D15	-	PB310A	2.76/(70)	3.19/(81)	-	.68/(17.5)	1.20/(30.5)	1.93/(49)	1.02/(26)
				PB410A	2.76/(70)	3.19/(81)	-	.68/(17.5)	1.20/(30.5)	2.95/(75)	1.02/(26)
A16	-	D25	-	PB316A	3.39/(86)	3.78/(96)	-	.68/(17.5)	1.20/(30.5)	1.93/(49)	1.02/(26)
				PB416A	3.39/(86)	3.78/(96)	-	.68/(17.5)	1.20/(30.5)	2.95/(75)	1.02/(26)
B6, T6	-	-	DD24	PB306	2.76/(70)	3.15/(80)	-	1.26/(32)	1.69/(43)	2.56/(65)	1.06/(27)
				PB406	2.76/(70)	3.15/(80)	-	1.26/(32)	1.69/(43)	3.54/(90)	1.06/(27)
B10, T10	V3	-	DD42	PB310	3.27/(83)	3.66/(93)	-	1.26/(32)	1.69/(43)	2.64/(67)	1.06/(27)
				PB410	3.27/(83)	3.66/(93)	-	1.26/(32)	1.69/(43)	3.62/(92)	1.06/(27)
B16, T16	C6, V6	D40	DD72	PB316	4.06/(103)	4.49/(114)	-	1.26/(32)	1.69/(43)	2.64/(67)	1.06/(27)
				PB416	4.06/(103)	4.49/(114)	-	1.26/(32)	1.69/(43)	3.62/(92)	1.06/(27)
B24, T24, K12	V10, V16	D64	DD108	PB324	5.12/(130)	5.51/(140)	-	1.26/(32)	1.69/(43)	2.64/(67)	1.06/(27)
				PB424	5.12/(130)	5.51/(140)	-	1.26/(32)	1.69/(43)	3.62/(92)	1.06/(27)
B48, K24, V32	V20, V26	D128	DD216	PB348	5.83/(148)	6.50/(165)	-	2.76/(70)	3.54/(90)	6.18/(157)	1.61/(41)
				PB448	5.83/(148)	6.50/(165)	-	2.76/(70)	3.54/(90)	6.81/(173)	1.61/(41)

Dimensions
A3/A4
D7/D8
only

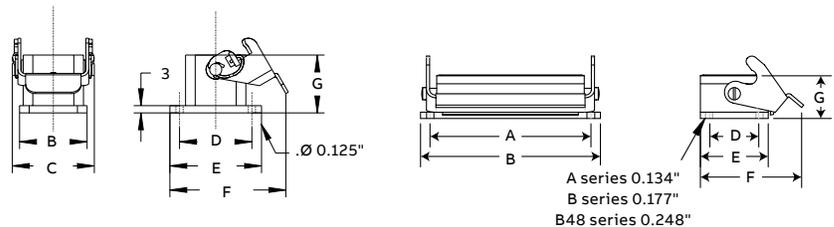

* Suffix: A – Aluminum, P – Plastic.

Technical information

Mounting dimensions for screw and crimp terminal inserts

Housing series					Dimensions are in inches/(millimeters)				
A, B, T, K	C, V	D	DD	Mating	A	B	C	D	E
A3, A4	-	-	-	Both	-	0.83/(21)	-	0.83/(21)	0.98/(25)
				Female	-	0.83/(21)	-	0.83/(21)	1.25/(31.8)
				Male	-	0.83/(21)	-	0.83/(21)	1.19/(30.2)
A10	-	D15	-	Female	1.95/(49.5)	2.22/(56.5)	0.63/(16)	1.34/(34)	1.14/(29)
				Male	1.95/(49.5)	2.22/(56.5)	0.63/(16)	1.34/(34)	1.26/(32)
A16	-	D25	-	Female	2.60/(66)	2.87/(73)	0.63/(16)	1.34/(34)	1.14/(29)
				Male	2.60/(66)	2.87/(73)	0.63/(16)	1.34/(34)	1.26/(32)
A32	-	D50	-	Female	2.60/(66)	2.87/(73)	0.63/(16) x 2	1.34/(34)	1.14/(29)
				Male	2.60/(66)	2.87/(73)	0.63/(16) x 2	1.34/(34)	1.26/(32)
B6, T6	-	-	DD24	Female	1.73/(44)	2.01/(51)	1.063/(27)	1.34/(34)	1.46/(37)
				Male	1.73/(44)	2.01/(51)	1.063/(27)	1.34/(34)	1.38/(35)
B10, T10	V3	-	DD42	Female	2.24/(57)	2.52/(64)	1.063/(27)	1.34/(34)	1.46/(37)
				Male	2.24/(57)	2.52/(64)	1.063/(27)	1.34/(34)	1.38/(35)
B16, T16	C6, V6	D40	DD72	Female	3.05/(77.5)	3.33/(84.5)	1.063/(27)	1.34/(34)	1.48/(37.5)
				Male	3.05/(77.5)	3.33/(84.5)	1.063/(27)	1.34/(34)	1.40/(35.5)
B24, T24, K12	V10, V16	D64	DD108	Female	4.09/(104)	4.37/(111)	1.063/(27)	1.34/(34)	1.48/(37.5)
				Male	4.09/(104)	4.37/(111)	1.063/(27)	1.34/(34)	1.40/(35.5)
B32	C12	D80	DD144	Female	3.05/(77.5)	3.33/(84.5)	1.063/(27) x 2	1.34/(34)	1.48/(37.5)
				Male	3.05/(77.5)	3.33/(84.5)	1.063/(27) x 2	1.34/(34)	1.40/(35.5)
B48, K24	V20, V26, V32	D128	DD216	Female	4.09/(104)	4.37/(111)	1.063/(27) x 2	1.34/(34)	1.48/(37.5)
				Male	4.09/(104)	4.37/(111)	1.063/(27) x 2	1.34/(34)	1.40/(35.5)

Dimensions

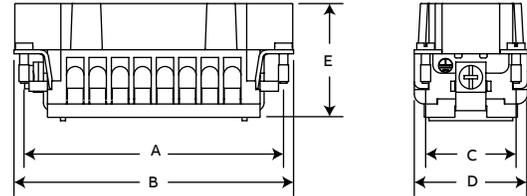

Technical information

Insert screw torque specifications

Insert mounting screws accept a Pozi-drive screwdriver head. Common cross-point or bladed screwdrivers will also work. Specs refer to Pozi-drive or bladed common torque only.

Series	Screw location	Unit of measure screwdriver	Pozi-drive point screwdriver	Std. straight-blade
A3	Wire termination screw	Newton meters	0.4	0.9
A4		Inch ounces	57	127
	Insert grounding screw	Newton meters	0.6	0.8
		Inch ounces	85	113
D7	Grounding screw	Newton meters	0.4	0.4
D8		Inch ounces	57	57
A10	Wire termination screw	Newton meters	0.4	0.9
A16		Inch ounces	57	127
A32	Insert fastening screw	Newton meters	0.7	1.1
		Inch ounces	99	156
	Insert grounding screw	Newton meters	0.7	1.3
		Inch ounces	99	184
D15	Insert fastening screw	Newton meters	0.7	1.1
D25		Inch ounces	99	156
D50	Insert grounding screw	Newton meters	0.7	1.3
		Inch ounces	99	184
B	Wire termination screw	Newton meters	0.4	0.6
T		Inch ounces	57	85
V	Insert fastening screw	Newton meters	0.7	1.1
		Inch ounces	99	156
	Insert grounding screw	Newton meters	1.2	1.9
		Inch ounces	170	269
C	Wire termination screw	Newton meters	0.7	1.3
		Inch ounces	99	184
	Insert fastening screw	Newton meters	0.7	1.1
		Inch ounces	99	156
	Insert grounding screw	Newton meters	2.3	2.3
		Inch ounces	326	326
K	Wire termination screw	Newton meters	0.5/1.4*	-
		Inch ounces	71/198*	
	Insert fastening screw	Newton meters	0.7	
		Inch ounces	99	
	Insert grounding screw	Newton meters	2.3	
		Inch ounces	326	

* 16 A/80 A contacts.

Note: Inch ounces/16.0 = pound/inches.

Technical information

Mounting dimensions for wiring adapters

Insert series	Cat. no.	Dimensions are in inches/(millimeters)							
		A	B	C	D	E	F	G	H
B6	FS106WAL	1.73/(44)	2.01/(51)	1.03/(26.3)	1.06/(27)	1.34/(34)	1.77/(45)	2.28/(58)	3.54/(90)
	FS106WAR								
	MS206WAL								
	MS206WAR								
B10	FS110WAL	2.13/(54)	2.52/(64)	1.55/(39.5)	1.06/(27)	1.34/(34)	1.77/(45)	2.28/(58)	3.54/(90)
	FS110WAR								
	MS210WAL								
	MS210WAR								
B16	FS116WAL	3.05/(77.5)	3.32/(84.5)	2.33/(59.3)	1.06/(27)	1.34/(34)	1.77/(45)	2.28/(58)	3.54/(90)
	FS116WAR								
	MS216WAL								
	MS216WAR								
B24	FS124WAL	4.09/(104)	4.37/(111)	3.36/(85.7)	1.06/(27)	1.34/(34)	1.77/(45)	2.28/(58)	3.54/(90)
	FS124WAR								
	MS224WAL								
	MS224WAR								
D40	FS340WAL	3.05/(77.5)	3.27/(83)	2.21/(56)	1.06/(27)	1.34/(34)	3.19/(81)	4.53/(115)	5.12/(130)
	MS440WAL								
D64	FS364WAL	4.09/(104)	4.33/(110)	3.39/(86.3)	1.06/(27)	1.34/(34)	3.19/(81)	4.53/(115)	5.12/(130)
	MS464WAL								

Dimensions

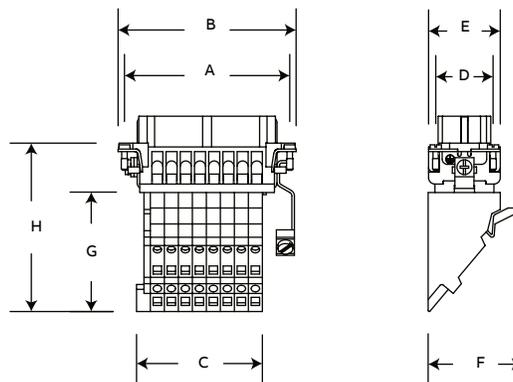

-WAL – Ground left, -WAR – Ground right.

Technical information

Panel cut out dimensions for panel bases

Housing series				Dimensions are in inches/(millimeters)				
A, B, T, K	C, V	D	DD	A	B	C	D	E
A3, A4	-	D7, D8	-	0.83/(21)	1.18/(30)	0.83/(21)	-	0.125/(3.2)
A10	-	D15	-	1.71/(43.5)	2.76/(70)	0.95/(24)	0.68/(17.5)	0.134/(3.4)
A16	-	D25	-	2.36/(60)	3.39/(86)	0.95/(24)	0.68/(17.5)	0.134/(3.4)
A32	-	D50	-	2.36/(60)	3.62/(92)	1.89/(48)	1.65/(28)	0.177/(4.5)
B6, T6	-	-	DD24	1.42/(36)	2.76/(70)	1.38/(35)	1.26/(32)	0.177/(4.5)
B10, T10	V3	-	DD42	1.93/(49)	3.27/(83)	1.38/(35)	1.26/(32)	0.177/(4.5)
B16, T16	C6, V6	D40	DD72	2.84/(72)	4.06/(103)	1.38/(35)	1.26/(32)	0.177/(4.5)
B24, T24, K12	V10, V16	D64	DD108	3.86/(98)	5.12/(130)	1.38/(35)	1.26/(32)	0.177/(4.5)
B32	C12	D80	DD144	2.84/(72)	4.33/(110)	2.80/(71)	2.56/(65)	0.216/(5.5)
B48, K24	V20, V26, V32	D128	DD216	3.86/(98)	5.83/(148)	2.80/(71)	2.76/(70)	0.248/(6.3)

Dimensions

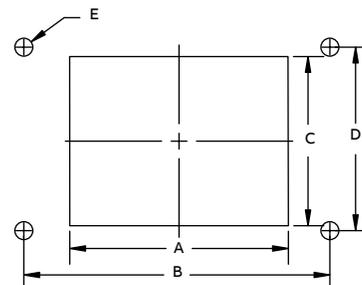
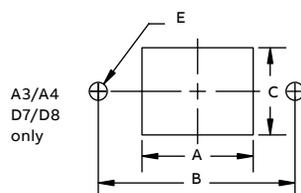

* Dimensions reflect dual inserts mounting.

Technical information

Mounting dimensions for double post hoods

Cat. no.	Housing series				Dimensions are in inches/(millimeters)		
	A, B, T, K	C, V	D	DD	A	B	C
SH_32A	A32	-	D50	-	3.23/(82)	2.21/(56)	2.99/(76)
TH_32A	-	-	-	-	3.23/(82)	2.21/(56)	2.99/(76)
SH_10	-	-	-	-	2.87/(73)	1.69/(43)	2.05/(52)
M3SH_10H_---	B10, T10	V3	-	DD42	2.87/(73)	1.69/(43)	2.05/(52)
TH_10	-	-	-	-	2.87/(73)	1.69/(43)	2.05/(52)
TH_10H_---	-	-	-	-	2.87/(73)	1.69/(43)	2.05/(52)
SH_16	-	-	-	-	3.70/(94)	1.69/(43)	2.56/(65)
SH_16H	-	-	-	-	3.70/(94)	1.69/(43)	2.99/(76)
M5SH_16L	B16, T16	C6, V6	D40	DD72	3.70/(94)	1.69/(43)	2.36/(60)
TH_16	-	-	-	-	3.70/(94)	1.69/(43)	2.56/(65)
TH_16H	-	-	-	-	3.70/(94)	1.69/(43)	2.99/(76)
TH_16L	-	-	-	-	3.70/(94)	1.69/(43)	2.36/(60)
SH_24	-	-	-	-	4.72/(120)	1.69/(43)	2.36/(60)
SH_24H	-	-	-	-	4.72/(120)	1.69/(43)	2.99/(76)
M7TH_24	B24, T24, K12	V10, V16	D64	DD108	4.72/(120)	1.69/(43)	2.21/(56)
TH_24H	-	-	-	-	4.72/(120)	1.69/(43)	2.99/(76)
TH424RC	-	-	-	-	4.72/(120)	1.69/(43)	2.99/(76)
SH_32	B32	C12	D80	DD144	3.70/(94)	3.11/(79)	3.15/(80)
TH_32	-	-	-	-	3.70/(94)	3.11/(79)	3.15/(80)

Dimensions

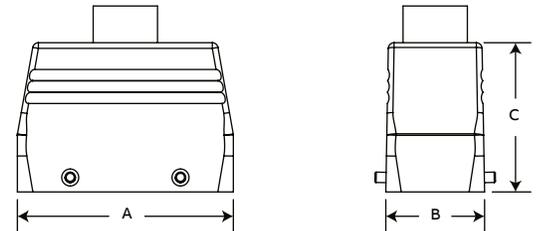

Suffix: A – Aluminum, P – Plastic, H – High profile, L – Low profile, RC – Ribbon cable (top).

Technical information

Mounting dimensions for single post hoods

Cat. no.	Housing series				Dimensions are in inches/(millimeters)		
	A, B, T, K	C, V	D	DD	A	B	c
SH603A(P)V	A3, A4	-	D7, D8	-	1.04/(26.5)	1.04/(26.5)	1.89/(48)
TH803A(P)V	-	-	-	-	1.04/(26.5)	1.04/(36.5)	1.89/(48)
SH_10A	-	-	-	-	2.48/(63)	1.42/(36)	2.60/(66)
SH_10AL	A10	-	D15	-	2.48/(63)	1.16/(29.5)	2.09/(53)
TH_10A	-	-	-	-	2.48/(63)	1.42/(36)	2.60/(66)
TH_10AL	-	-	-	-	2.48/(63)	1.16/(29.5)	2.09/(53)
SH_16A	-	-	-	-	3.13/(79.5)	1.42/(36)	2.84/(72)
SH_16AL	A16	-	D25	-	3.13/(79.5)	1.16/(29.5)	2.28/(58)
TH_16A	-	-	-	-	3.13/(79.5)	1.42/(36)	2.84/(72)
TH_16AL	-	-	-	-	3.13/(79.5)	1.16/(29.5)	2.28/(58)
SH_606	-	-	-	-	2.36/(60)	1.69/(43)	1.69/(43)
M2SH_606Hxxx	B6, T6	-	-	DD24	2.36/(60)	1.69/(43)	2.84/(72)
TH_806	-	-	-	-	2.36/(60)	1.69/(43)	1.69/(43)
TH_806Hxxx	-	-	-	-	2.36/(60)	1.69/(43)	2.84/(72)
SH_610	-	-	-	-	2.87/(73)	1.69/(43)	2.05/(52)
M3SH_610Hxxx	B10, T10	V3	-	DD42	2.87/(73)	1.69/(43)	2.84/(72)
TH_810	-	-	-	-	2.87/(73)	1.69/(43)	2.05/(52)
TH_810Hxxx	-	-	-	-	2.87/(73)	1.69/(43)	2.84/(72)
SH_616	-	-	-	-	3.70/(94)	1.69/(43)	2.56/(65)
SH_616H	-	-	-	-	3.70/(94)	1.69/(43)	2.99/(76)
SH_616L	-	-	-	-	3.70/(94)	1.69/(43)	2.36/(60)
M5TH_816	B16, T16	C6, V6	D40	DD72	3.70/(94)	1.69/(43)	2.56/(65)
TH_816H	-	-	-	-	3.70/(94)	1.69/(43)	2.99/(76)
TH_816L	-	-	-	-	3.70/(94)	1.69/(43)	2.36/(60)
TH816RC	-	-	-	-	3.70/(94)	1.69/(43)	2.99/(76)
SH_624	-	-	-	-	4.72/(120)	1.69/(43)	2.99/(76)
M7SH_624L	B24, T24	V10, V16	D64	DD108	4.72/(120)	1.69/(43)	2.36/(60)
TH_824	-	-	-	-	4.72/(120)	1.69/(43)	2.99/(76)
TH824L	K12	-	-	-	4.72/(120)	1.69/(43)	2.36/(60)
TH624RC	-	-	-	-	4.72/(120)	1.69/(43)	2.99/(76)
SH_48	B48, K24	V20, V26	D128	DD216	5.16/(131.5)	3.50/(89)	3.78/(96)
TH_48	-	V32	-	-	5.16/(131.5)	3.50/(89)	3.78/(96)

Dimensions

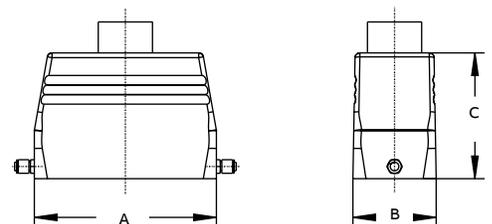

Suffix: P – Plastic, H – High profile, L – Low profile, RC – Ribbon cable (top entry only).

Technical information

Mounting dimensions for lever coupler hoods

Mounting dimensions for double lever coupler hoods

Cat. no.	Housing series				Dimensions (in)/(mm)				
	A, B, T, K	C, V	D	DD	A	B	C	D	E
CH610E	B10, T10	V3	-	DD42	2.87/(73)	4.33/(110)	1.69/(43)	2.28/(58)	2.02/(51.5)
CH610EHxxx					2.87/(73)	4.33/(110)	1.69/(43)	2.28/(58)	2.87/(73)
CH_16E	B16, T16	C6, V6	D40	DD72	3.70/(94)	5.16/(131)	1.69/(43)	2.28/(58)	2.72/(69)
CH_16EH					3.70/(94)	5.16/(131)	1.69/(43)	2.28/(58)	3.15/(80)
CH616ERC	B24, T24, K12	C6, V6	D40	DD72	3.70/(94)	5.16/(131)	1.69/(43)	2.28/(58)	3.15/(80)
CH_24E					4.72/(120)	6.18/(157)	1.69/(43)	2.28/(58)	3.15/(80)
CH624ERC	B32	C12	D80	DD144	4.72/(120)	6.18/(157)	1.69/(43)	2.28/(58)	3.15/(80)
CH_32E					3.70/(94)	5.28/(134)	3.11/(79)	3.62/(92)	3.23/(82)

Dimensions

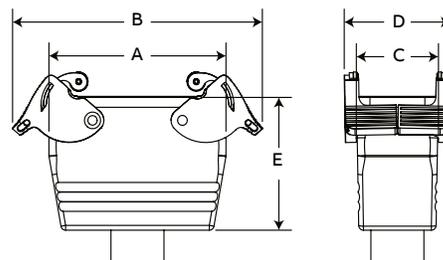

H – High profile, RC – Ribbon cable (top entry).

Mounting dimensions for single lever coupler hoods

Cat. no.	Housing series				Dimensions (in)/(mm)				
	A, B, T, K	C, V	D	DD	A	B	C	D	E
CH803A(P)*	A3, A4	-	D7, D8	-	1.34/(34)	-	1.04/(26.5)	1.43/(36.5)	2.02/(51.5)
CH810A	A10		D15		2.48/(63)		1.16/(29.5)	1.92 (49)	1.89/(48)
CH816A	A16	C6, V6	D25		3.13/(79.5)		1.16/(29.5)	1.92 (49)	2.09/(53)
CH806	B6, T6	-	-	DD24	2.36/(60)	-	1.69/(43)	2.56/(65)	2.02/(51.5)
CH806Hxxx					2.36/(60)		1.69/(43)	2.56/(65)	2.87/(73)
CH810	B10, T10	V3	-	DD24	2.87/(73)	-	1.69/(43)	2.64/(67)	2.02/(51.5)
CH810Hxxx					2.87/(73)		1.69/(43)	2.64/(67)	2.87/(73)
CH_16					3.70/(94)		1.69/(43)	2.64/(67)	2.72/(69)
CH_16H	B16, T16	C6, V6	D40	DD72	3.70/(94)	-	1.69/(43)	2.64/(67)	3.15/(80)
CH616RC					3.70/(94)		1.69/(43)	2.64/(67)	3.15/(80)
CH_24	B24, T24	V10, V16	D64	DD108	4.72/(120)	-	1.69/(43)	2.64/(67)	3.15/(80)
CH824RC					4.72/(120)		1.69/(43)	2.64/(67)	3.15/(80)

Dimensions

A3/A4
D7/D8
Only

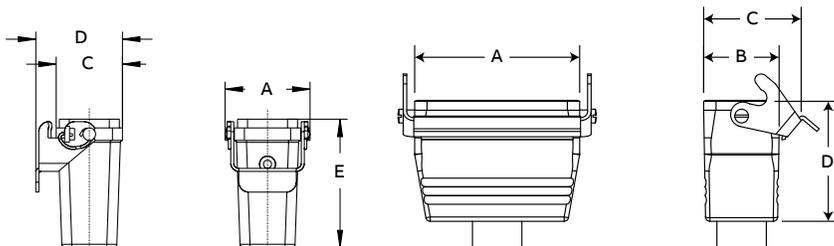

*Suffix: A – Aluminum, P – Plastic, H – High profile, L – Low profile, RC – Ribbon cable (top entry only).

Technical information

Mounting dimensions for double post box bases (reverse locking)

Mounting dimensions for double post box bases (reverse locking)

Cat. no.	Housing series				Dimensions (in)/(mm)					
	A, B, T, K	C, V	D	DD	A	B	C	D	E	F
BB_32A	A32	-	D50	-	3.70/(94)	4.17/(106)	1.81/(46)	2.32/(59)	3.11/(79)	3.20/(81.5)
BB_32A100					3.70/(94)	4.17/(106)	1.81/(46)	2.32/(59)	3.11/(79)	3.20/(81.5)
BB_10	B10, T10	V3	-	DD42	3.23/(82)	3.66/(93)	1.56/(40)	2.05/(52)	2.87/(73)	2.05/(52)
BB_10H*					3.23/(82)	3.66/(93)	1.77/(45)	2.24/(57)	2.97/(75.5)	2.91/(74)
BB_16	B16, T16	C6, V6	D40	DD72	4.13/(105)	4.61/(117)	1.77/(45)	2.24/(57)	2.97/(75.5)	2.68/(68)
BB_24					5.20/(132)	5.67/(144)	1.77/(45)	2.24/(57)	2.97/(75.5)	2.68/(68)
BB_24	B24, T24,	C6, V6	D40	DD72	5.20/(132)	5.67/(144)	1.77/(45)	2.24/(57)	2.97/(75.5)	2.68/(68)
BB_24H*	K12				5.20/(132)	5.67/(144)	1.77/(45)	2.24/(57)	2.97/(75.5)	3.31/(84)

Dimensions

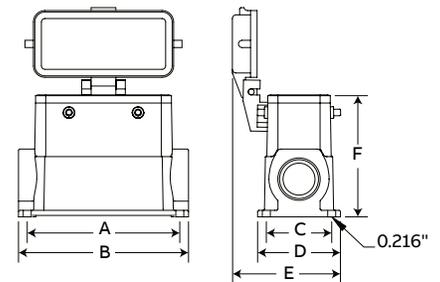

* H – High profile.

Mounting dimensions for double post box panel bases (reverse locking)

Cat. no.	Housing series				Dimensions (in)/(mm)					
	A, B, T, K	C, V	D	DD	A	B	C	D	E	F
PB232A	A32	-	D50	-	3.62/(92)	4.02/(102)	1.65/(42)	2.24/(57)	3.15/(80)	1.10/(28)
PB210	B10, T10	V3	-	DD42	3.27/(83)	3.66/(93)	1.26/(32)	1.69/(43)	2.68/(68.5)	1.06/(27)
PB216	B16, T16	C6, V6	D40	DD72	4.06/(103)	4.49/(114)	1.26/(32)	1.69/(43)	2.68/(68.5)	1.06/(27)
PB224	B24, T24,	C6, V6	D40	DD72	5.12/(130)	5.51/(140)	1.26/(32)	1.69/(43)	2.68/(68.5)	1.06/(27)
	K12									

Dimensions

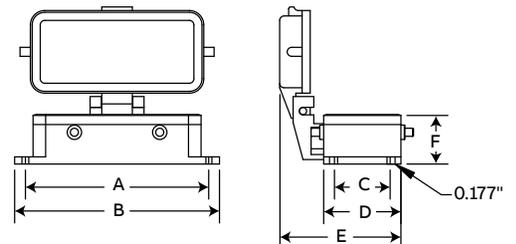

Technical information

Mounting dimensions for double lever hoods (reverse locking) & dust covers for housings

Mounting dimensions for double lever hoods (reverse locking)

Housing series					Dimensions are in inches/(millimeters)				
A, B, T, K	C, V	D	DD	Cat. no.	A	B	C	D	E
A32	–	D50		LH_32A	3.23/(82)	5.04/(128)	2.21/(56)	2.76/(70)	2.99/(76)
B10, T10	V3	–	DD42	LH_10E	2.87/(73)	4.33/(110)	1.69/(43)	2.28/(58)	1.89/(48)
				LH_10EH*	2.87/(73)	4.33/(110)	1.69/(43)	2.28/(58)	2.84/(72)
B16, T16	C6, V6	D40	DD72	LH_16E	3.70/(94)	5.16/(131)	1.69/(43)	2.28/(58)	2.56/(65)
				LH_16EH*	3.70/(94)	5.16/(131)	1.69/(43)	2.28/(58)	2.99/(76)
B24, T24, K12	V10, V16	D64	DD108	LH_24E	4.72/(120)	6.18/(157)	1.69/(43)	2.28/(58)	2.99/(76)

Dimensions

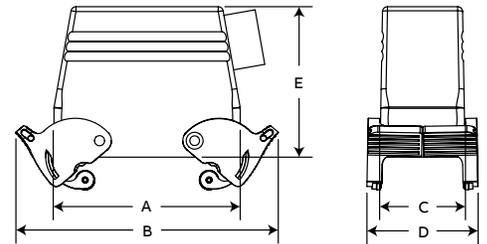

*H – High Profile



Dust covers for housings

Housing series				For single-lever housings	For double-lever housings	For single-post housings	For double-post housings
A, B, T, K	C, V	D	DD				
A3, A4	–	D7, D8	–	DCL103A-1	–	–	–
A10	–	D15	–	DCL110A-1	–	DCS110A-1	–
A16	–	D25	–	DCL116A-1	–	DCS116A-1	–
A32	–	D50	–	–	DCL232A-1/ DCL432A-1*	–	DCS232A-1
B6, T6**	–	–	DD24	DCL106B-1	–	–	–
B10, T10**	V3	–	DD42	DCL110B-1	DCL210B-1/ DCL410B-1*	–	–
B16, T16**	C6, V6	D40	DD72	DCL116B-1	DCL216B-1/ DCL416B-1*	–	–
B24, T24**, K12	V10, V16	D64	DD108	DCL124B-1	DCL224B-1/ DCL424B-1*	–	–

* Comes with gasket for hoods with levers and without gaskets.

** Dust covers tested only to 125 °C (if applied to 200 °C Series T).

Technical information

Gaskets

Gaskets

Cat. no.		Housing series			
Panel base, flat	Molded edge contour*	A, B, T, K	C, V	D	DD
A04XFGP	A04XMEC	A3, A4	-	D7, D8	-
A10XFGP	A10XMEC	A10	-	D15	-
A16XFGP	A16XMEC	A16	-	D25	-
A32XFGP	A32XMEC	A32	-	D50	-
B6XFGP	B6XMEC	B6, T6**	-	-	DD24
B10XFGP	B10XMEC	B10, T10**	V3	-	DD42
B16XFGP	B16XMEC	B16, T16**	V6, C6	D40	DD72
B24XFGP	B24XMEC	B24, T24**, K12	V10, V16	D64	DD108
B32XFGP	B32XMEC	B32	C12	D80	DD144
B48XFGP	B48XMEC	B48, K24	V20, V26, V32	D128	DD216

* Install with silicone sealant/adhesive for industrial use.

** For T Series 200 °C applications, specify catalogue number except use "T" prefix instead of "B" for gaskets. EX: use "T16XFGP" for panel base gaskets.

Technical information

Coding pins, guide pins and sleeves can be used in all series housings, with all inserts

- 01 Coding pin – PC600
- 02 Guide pin – MG601
- 03 Guide sleeve – FG602



Coding pins:

Used for rejection in multiple “same size or series” insert/hood installations. Patterns show examples of rejection coding pins installed.

Coding possibilities for single insert series

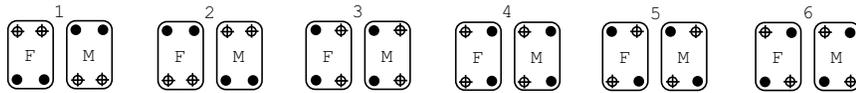

Coding possibilities for double insert series

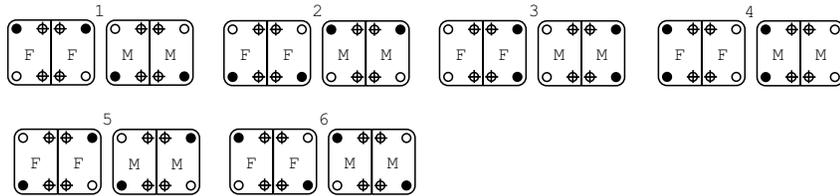

Guide pins and sleeves:

Perform same function as coding pins and/or aid high-density insert mating as well.

Coding possibilities for single insert series

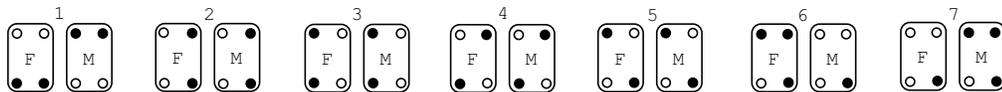

Coding possibilities for double insert series

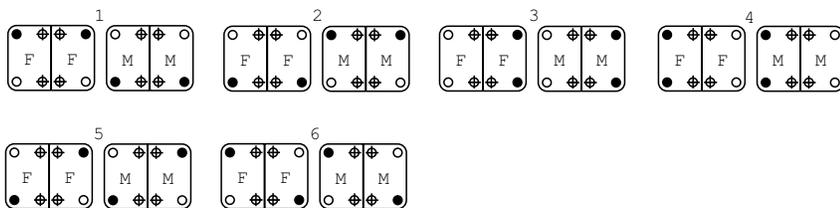

- Male guide pins or coding pins
- Female guide sleeves
- ⊕ Mounting screw

Technical information

Metric PG-to-NPT, ISO-to-NPT thread adapters & cord grip connectors

Metric PG-to-NPT thread adapters

	Cat. no.	NPT thread (mating) (in.)	Thread (at housing)
 <p>Supplied standard with all hoods and bases. Special sizes/hood combinations available.</p>	PG11-38	$\frac{3}{8}$	PG11
	PG16-50	$\frac{1}{2}$	PG16
	PG21-75	$\frac{3}{4}$	PG21
	PG29-100	1	PG29
	PG29-125	$1\frac{1}{4}$	PG29
	PG36-125	$1\frac{1}{4}$	PG36
	PG36-150	$1\frac{1}{2}$	PG36
PG42-200	2	PG42	

Metric ISO-to-NPT thread adapters

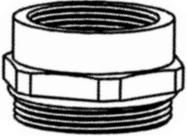
	Cat. no.	NPT thread (mating) (in.)	Thread (at housing)
	M20-50	$\frac{1}{2}$	M20
	M20-75	$\frac{3}{4}$	M25
	M32-100	1	M32

Metric cord grip connectors

	Cat. no.	Cable O.D. (in.)		Thread (at housing)
		Min.	Max.	
	CG11-38	0.200	0.470	PG11
	CG11-38P*	0.325	0.340	PG11
	CG135-50	0.285	0.545	PG13.5
	CG16-50	0.285	0.625	PG16
	CG21-75	0.395	0.790	PG21
	CG29-100	0.780	0.060	PG291

Standard European style – Can be specified/
supplied with hoods and bases.

* Plastic

Technical information

Conduit entry blind plug & non-metallic cord grip fittings

Conduit entry blind plug

	Cat. no.	Thread (at housing)
	CXP722	PG13.5
	CXP723	PG16
	CXP724	PG21
	CXP725	PG29

Non-metallic cord grip fittings

	NPT threads		Cord range		Thread size (in.)
	Cat. no.	In.	mm		
	CC-NPT38-G	0.197-0.394	5-10		$\frac{3}{8}$
	CC-NPT12-G	0.394-0.551	10-14		$\frac{1}{2}$
	CC-NPT34-G	0.512-0.709	13-18		$\frac{3}{4}$
	CC-NPT1-G	0.709-0.984	18-25		1

	PG threads		Cord range		Thread size (in.)
	Cat. no.	In.	mm		
	CC-PG11-G	0.197-0.394	5-10		11
	CC-PG135-G	0.336-0.473	6-12		13.5
	CC-PG16-G	0.394-0.551	10-14		16
	CC-PG21-G	0.512-0.709	13-18		21
	CC-PG29-G	0.709-0.984	18-25		29
	CC-PG36-G	0.867-1.260	22-32		36

Technical information

Instructions for connection with fiber optic (POF Cable)

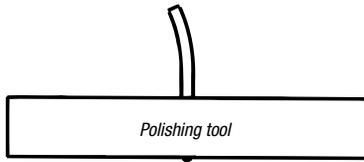

1) Before crimping the POF* cable, 1.0 mm to the glass fiber cable contact, the end of the fiber has to be polished. Stick end of POF cable into polishing tool and grind on a plane surface (e.g. glass plate). Wipe off any residues after polishing. The best optical damping values are achieved with wet-polishing-procedure.

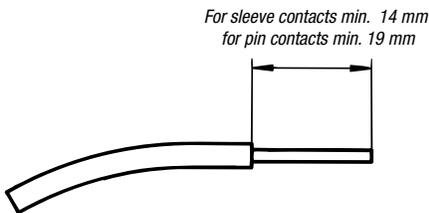

2) Strip 1.0 mm POF cable on min. 14 mm for D sleeve contacts and min. 19 mm for D pin contacts.

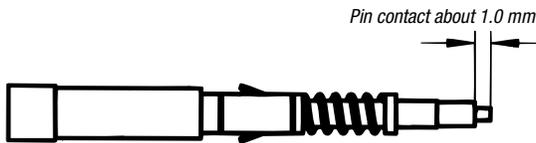

3) Insert stripped POF cable in sleeve or pin contact until stop. The optical fiber should then stick about 1 mm out of the contact.

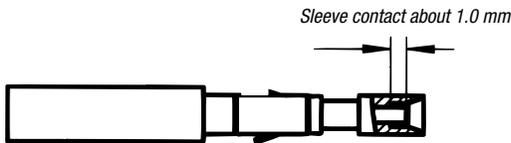

4) Optical fiber crimping:

Adjust the positioning sleeve into the corresponding inlet of the crimping tool with the stop screw at 1.45 mm (if necessary check with gauge pin, diameter 1.45 mm, with closed crimping tool).

Insert the glass fiber cable contact together with the POF cable through the crimp opening of the crimping tool into the positioning sleeve.

By pressure on the contact, the fiber inside the contact will be locked into the right position for the fiber crimping. Continue pressure until the release mechanism is heard.

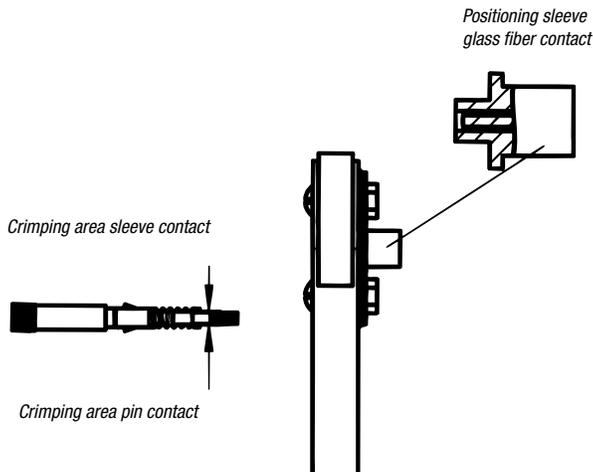

* POF = Polymer optical fiber