

Clamps

Waterpipe ground clamps



Cat. no.	Ground wire size (AWG)	Water pipe size (in.)
2-TB	#6, #4, #2	½, ¾, 1 or rebar 410
3-TB	#6, #4, #2	1¼, 1½ or 2
4-TB	#6, #4, #2	2½, 3 or 3½
5-TB	#6, #4, #2	4, 4½ or 5
6-TB	#6, #4, #2	6



Malleable iron crossbar, steel U-bolt complete with copper cable clamp with serrations.

Waterpipe ground clamps



Cat. no.	Ground wire size (AWG)	Water pipe size (in.)
3902BU*	#4-4/0	½-1
3903BU*	#4-4/0	1¼-2
3904BU*	#4-4/0	2½-3½
3905BU*	#4-4/0	4-5
3906BU*	#4-4/0	6
3907BU*	#4-4/0	8
3908BU*	#4-4/0	10
3909BU*	#4-4/0	12



Material: Bronze U-bolt and nut complete with bronzed aluminum cap and crossbar with a bright dip finish. *UL listed for direct burial.

Waterpipe ground clamps



Cat. no.	Ground wire size (AWG)	Water pipe size (in.)
3902-TB	#4-4/0	½-1
3903	#4-4/0	1¼-2
3904	#4-4/0	2½-3½
3905-TB	#4-4/0	4-5
3906-TB	#4-4/0	6
3907	#4-4/0	8
3908	#4-4/0	10
3909-TB	#4-4/0	12



Material: Steel U-bolt and nut complete with bronzed aluminum cap and crossbar cadmium plated plus gold chromate finish.

Ground clamps



Cat. no.	Material	Water pipe, copper tubing size (in.)	Ground rod size (in.)
3826*	Malleable iron	½, ¾	½-1
3846*	Bronze	½, ¾	½-1
3840-TB*	Malleable iron	½, ¾ or 1	½-1



* For unarmored copper wires #6, #4 AWG. UL approved for direct burial.
 • #8 thru #4 AWG. Not CSA certified

Ground clamps for K&L grade copper tubing only



Cat. no.	Ground wire size (AWG)	Water pipe, copper tubing size (in.)
3844*	#8-#4	½-1
3888**	#8-#4	½-1, also rebar 4-10

For armored and unarmored wires



* With steel screws.
 ** UL approved for direct burial. Silicon bronze screws.

Ground clamp accessories



Cat. no.	Description	For use with
10102-TB	For 1¼ to 1½ in. cables	#8-#2 AWG ground wire



Material: Malleable iron, zinc plated.



Cat. no.	For use with
10105	Single conductors #4 AWG solid to 2/0 AWG str.
10109	Single conductors 2/0 AWG solid to 4/0 AWG str.



Clamps



Type JAB — ground rod clamps

- Cast of high-strength corrosion-resistant copper alloy
- Both hex head and socket set screws available

- Long bearing surface of clamp on ground wire secures ground connection
- Listed for direct burial



Dimensions (in.)

Cat. no.	Socket set screw	Hex head Bolt	Nominal rod dia.		Wire range		A (max.) socket screw	A (max.) hex bolt	Screw thread size UNC-2A	B	C	D		
			(in.)	(mm)	Max. (AWG)	Min. (AWG)							Max. (mm ²)	Min. (mm ²)
JAB12*		JAB12H	1/2	12.7	2 str.	10 sol.	33.6	5.2	1 ¹⁹ / ₃₂	2 ³ / ₃₂	7/16-14	2 ⁷ / ₃₂	7/8	1 ¹⁹ / ₃₂
JAB58		JAB58H	5/8	15.8	1/0 str.	8 sol.	53.4	8.3	1 ²⁷ / ₃₂	2 ¹³ / ₆₄	7/16-14	2 ⁹ / ₃₂	1	1 ¹¹ / ₁₆
JAB34		JAB34H	3/4	19.0	1/0 str.	8 sol.	53.4	8.3	2	2 ¹¹ / ₃₂	7/16-14	1 ¹ / ₁₆	1	5 ¹ / ₆₄
-		JAB34C	3/4 + 5/8	15.8 to 19.0	3/0 str.	8 sol.	95.0	8.3	-	2 ¹¹ / ₃₂	7/16-14	1 ¹ / ₈	1 ¹ / ₃₂	1 ³ / ₁₆
JAB1		JAB1H	1	25.0	3/0 str.	8 sol.	107.1	8.3	2 ¹ / ₄	3	7/16-14	1 ¹¹ / ₃₂	1 ¹ / ₁₆	1

Diagrams

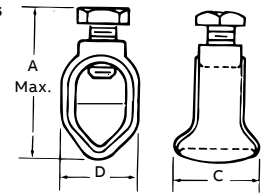

* CSA not applicable.
Add suffix P to cat. no. for tin-plated clamp.



Type G — budget line ground clamps

- A dependable ground connection offered at a substantial saving
- Cast of high-strength corrosion-resistant copper alloy

- Hex head bolts
- Simplified compact design will make a lasting, trouble-free connection
- Listed for direct burial



Dimensions (in.)

Cat. no.	Nominal rod dia.		Wire range		A (Max.) Bolt	Screw Thread Size UNC-2A	B	C	D	E		
	(in.)	(mm)	Max. (AWG)	Min. (AWG)							Max. (mm ²)	Min. (mm ²)
G3-TB*	3/8	9.5	4 str.	10 sol.	21.1	5.2	1-3/8	5/16-18	1 ¹ / ₁₆	1/2	2 ⁷ / ₆₄	3/8
G4	1/2	12.7	2 str.	10 sol.	33.6	5.2	-	3/8-16	2 ⁷ / ₃₂	3/8	3 ⁷ / ₆₄	1/2
G5	5/8	15.8	2 str.	10 sol.	33.6	5.2	-	3/8-16	2 ⁹ / ₃₂	3/8	4 ³ / ₆₄	1/2
G6	3/4	19.0	2 str.	10 sol.	33.6	5.2	-	3/8-16	1 ¹ / ₁₆	3/8	1 ³ / ₁₆	1/2

Diagrams

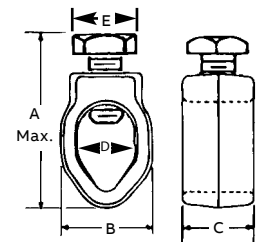

* Not UL listed and CSA not applicable.
Add suffix P to cat. no. for tin-plated clamp.

Clamps



Budget price cast bronze clamp

Similar to aluminum water pipe clamp but lighter in construction.



Cat. no.	Water pipe size (in.)	Conductor range (AWG)		Dimensions (in.)		
		Max.	Min.	A	B	C
JJR	½ to 1	#4 str.	#10 sol.	1 ¹⁹ / ₃₂	2 ⁷ / ₃₂	7/ ₈

Diagrams

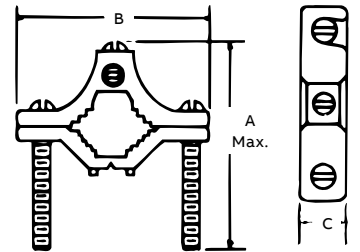

Add suffix C to cat. no. to specify plating.

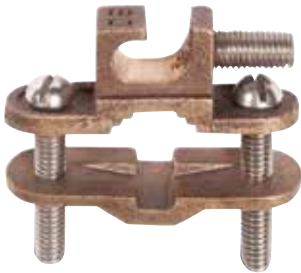

Type JDLI — direct burial ground clamp

Lay-in feature reduces installation time for difficult bends or continuous loops of ground wire.

- UL listed for direct burial in earth/concrete
- UL listed for connection to ground rod, pipe or rebar up to 1 in.
- Constructed from bronze alloy and high-performance stainless steel bolts
- Designed for easy installation of difficult bends or continuous loops



Cat. no.	Pipe size (in.)	Rebar size (in.)	Ground rod size (in.)	Conductor range (AWG)	Mech. conn./splice (UL Listed)
JDLI	½-1	¾-1	¼-1	#10 sol.-#2 str.	(2) #8 AWG sol.

Clamps



Type JWR — wide-range ground rod clamp

- Listed for direct burial in earth/concrete
- Constructed from bronze alloy and high-performance stainless steel bolt
- Provides wide range of connection sizes
- More than 300 lb torque capacity



Cat. no.	Nominal rod dia.		Wire range				Dimensions (in.)			
	(in.)	(mm)	Max. (AWG)	Min. (AWG)	Max. (mm ²)	Min. (mm ²)	A (max.) bolt	B	C	D
JWR	3/8*	9.5	1/0 str.	10 sol.	53.4	5.2	1.535	1.050	0.812	0.652
	1/2	12.7	1/0 str.	10 sol.	53.4	5.2	1.535	1.050	0.812	0.652
	5/8	15.8	1/0 str.	10 sol.	53.4	5.2	1.535	1.050	0.812	0.652
	3/4	19.0	1/0 str.	10 sol.	53.4	8.3	1.535	1.050	0.812	0.652

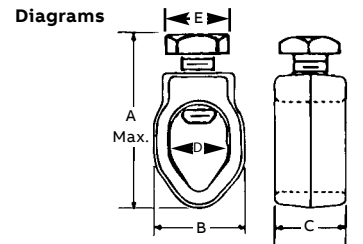

* 3/8 in. rod CSA not applicable/listed by UL.



Types GG and GGH — heavy-duty ground rod clamps

- Cast of high-strength corrosion-resistant copper alloy; two types of screws available
- Type GG has a socket set screw
- Type GGH has a hex head bolt
- Floating pressure bar distributes pressure evenly over a large area of the ground wire
- Axial groove keeps wire and rod in perfect alignment



Cat. no.		Nominal rod dia.		Wire range				A (max.)		Screw thread size UNC-2A			Dimensions (in.)	
		(in.)	(mm)	Max. (AWG)	Min. (AWG)	Max. (mm ²)	Min. (mm ²)	socket screw	hex bolt		B	C		
GG12	GG12H	1/2	12.7	2 str.	8 sol.	33.6	8.3	1 ¹³ / ₆₄	1 ¹³ / ₁₆	7/16-14	27/32	15/16		
GG58	GG58H	5/8	15.8	2/0 str.	8 sol.	53.6	8.3	1 ⁵¹ / ₆₄	2 ⁷ / ₃₂	7/16-14	61/64	15/16		
-	GG34H**	3/4	19.0	4/0 str.	8 sol.	120.6	8.3	-	3	1/2-14	1 3/8	1 3/4		

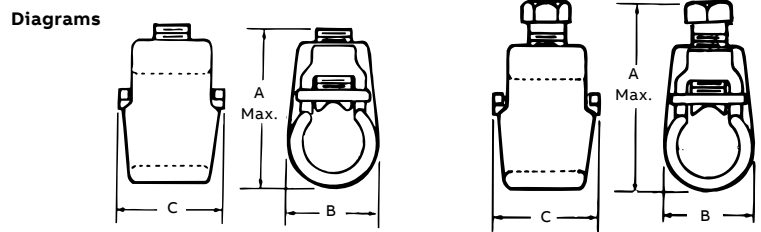

** CSA not applicable.
GG34H has no pressure bar or axial groove.
Add suffix P to cat. no. for tin-plated clamp.

Clamps



Budget price cast bronze clamps

- Type swings 360° for ease of alignment.
- Pipe clamping portion identical to “JA” clamp
- Pressure-bar type conduit hub adjusts to fit ½ in. or ¾ in. EMT or ½ in. rigid conduit
- Brass washer provides positive contact with grounding conductor
- Furnished with zinc-plated screws

Cat. no.	Conduit size	Water pipe size (in.)	Conductor range (AWG)	
			Max.	Min.
JPT	½ in. or ¾ in. EMT, ½ in. rigid	½ to 1	#6 sol.	#10 sol.
JPT2	½ in. or ¾ in. EMT, ½ in. rigid	1¼ to 2	#6 sol.	#10 sol.
JPT4	½ in. or ¾ in. EMT, ½ in. rigid	2½ to 4	#6 sol.	#10 sol.



Cast bronze clamps

- For connecting armored cable to water pipe.
- Clamping portion similar to standard “J” clamp
- Special pressure bar grips armor or outer cable insulation to reduce chance of grounding conductor being pulled out
- Furnished with zinc-plated screws



Cat. no.	Water pipe size (in.)	Conductor range (AWG)		Dimensions (in.)					
		Max.	Min.	A	B	C	D	E	G
JA	½ to 1	#6 sol.	#10 sol.	2¾	2 ¹¹ / ₃₂	²⁵ / ₃₂	2 ⁹ / ₃₂	¹⁵ / ₃₂	1 ⁷ / ₈
JA2	1¼ to 2	#6 sol.	#10 sol.	3¾	3½	¹³ / ₁₆	2 ⁹ / ₃₂	¹⁵ / ₃₂	1 ⁷ / ₈
JA2124	2½ to 4	#6 sol.	#10 sol.	6	6 ⁵ / ₁₆	1	2 ⁹ / ₃₂	¹⁵ / ₃₂	1 ⁷ / ₈

Diagrams

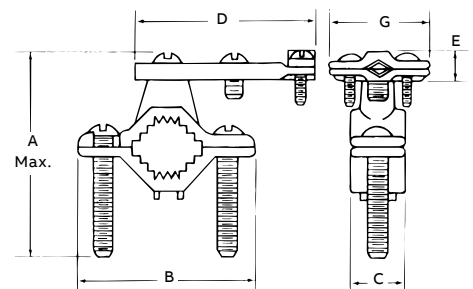

Add suffix C to cat. no. to specify plating.

Clamps



Cast bronze clamps for conduit

- For grounding rigid conduit systems
- Continuity from rigid conduit system to ground provided by cast bronze threaded conduit hub
- Hub swings 360° for easy alignment
- Heavy brass washer protects clamped grounding conductor
- Furnished with zinc-plated screws
- Cast bronze pipe clamping portion identical to that used in “JA” clamp



Cat. no.	Conduit size (in.)	Water pipe size (in.)	Conductor range (AWG)		Dimensions (in.)					
			Max.	Min.	A	B	C	D	E	G
JP12	½	½ to 1	#6 sol.	#10 sol.	2¾	2 ¹¹ / ₃₂	2 ³ / ₃₂	1 ⁹ / ₆₄	1	2½
JP212	½	1¼ to 2	#6 sol.	#10 sol.	3¾	3½	1 ³ / ₁₆	1 ⁹ / ₆₄	1	2½
JP212412	½	2½ to 4	#6 sol.	#10 sol.	6	6 ⁵ / ₁₆	1	1 ⁹ / ₆₄	1	2½
JP34	¾	½ to 1	#2/0 str.	#10 sol.	2¾	2 ¹¹ / ₃₂	2 ³ / ₃₂	2 ⁵ / ₁₆	1¼	2 ³ / ₁₆
JP234	¾	1¼ to 2	#2/0 str.	#10 sol.	3¾	3½	1 ³ / ₁₆	2 ⁵ / ₁₆	1¼	2 ³ / ₁₆
JP1	1	½ to 1	#3/0 str.	#10 sol.	2¾	2 ¹¹ / ₃₂	2 ³ / ₃₂	2 ⁵ / ₁₆	1½	2 ³ / ₈
JP21	1	1¼ to 2	#3/0 str.	#10 sol.	3¾	3½	1 ³ / ₁₆	2 ⁵ / ₁₆	1½	2 ³ / ₈
JP21241	1	2½ to 4	#3/0 str.	#10 sol.	6	6 ⁵ / ₁₆	1	2 ⁵ / ₁₆	1½	2 ³ / ₈

Diagrams

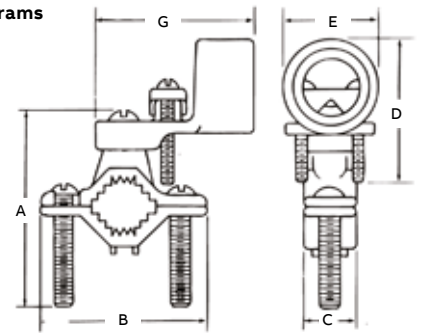

Add suffix C to cat. no. to specify plating.



Cast bronze clamps with copper strap

- Flexible copper strap makes alignment easy
- For grounding rigid conduit systems
- Same features as “JP” clamp plus flexible copper strap
- Strap helps protect conduit system from water system vibrations
- Furnished with zinc-plated screws

Cat. no.	Conduit size (in.)	Water pipe size (in.)	Conductor range (AWG)	
			Max.	Min.
JPS12	½	½ to 1	#6 sol.	#10 sol.
JPS34	¾	½ to 1	2/0 str.	#10 sol.
JPS1	1	½ to 1	3/0 str.	#10 sol.

Add suffix C to cat. no. to specify plating.

Clamps



Cast bronze ground clamps

- Connect copper ground wire to water pipe, copper tubing or ground rods
- High-strength, high-conductivity copper alloy (over 80% copper)
- UL approved for direct burial



Cat. no.	Water pipe size (in.)	Conductor range
JD	½ to 1	#2 str.–#10 str.
J2D	1¼ to 2	#2 str.–#10 str.



Type J – cast bronze ground clamps

- For connecting grounding conductor to water pipe or copper tube
- Cast of high-strength, highly conductive copper alloy
- Screws plated for corrosion resistance
- UL listed

Cat. no.	Water pipe size (in.)	Conductor range (AWG)		Dimensions (in.)		
		Max.	Min.	A	B	C
J	½ to 1	#2 str.	#10 sol.	2¾	2 ¹¹ / ₃₂	2 ³ / ₃₂
J2BB	1¼ to 2	#2 str.	#10 sol.	3¾	3½	1 ³ / ₁₆
J2124	2½ to 4	#2 str.	#10 sol.	6	6 ⁵ / ₁₆	1
J6	4¼ to 6	#2 str.	#10 sol.	7¼	8 ¹ / ₈	1

Diagrams

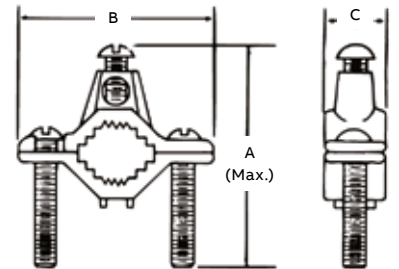

Clamps



Type GUV – U-bolt clamps

- Listed for direct burial in earth or concrete
- For connecting copper or copper-clad steel grounding conductor to ground rod, pipe or rebar
- Excellent for connecting multiple electrodes with a single cable as in substation grounding
- GUV body components are cast or forged from copper alloy and U-bolts are stainless steel
- Specially designed spacer provides proper alignment between cable and electrode and affords more positive contact area



Cat. no.	Conductor range Cu (AWG)		Nominal rod size (in.)		IPS pipe size (in.)		Dimensions (in.)		
	Max.	Min.	Max.	Min.	Max.	Min.	A	B	C
GUV584	#4	#8	3/4	5/8	3/8	–	2 ¹³ / ₁₆	1 ⁹ / ₁₆	2 ¹ / ₄
GUV5821	2/0	#4	3/4	5/8	3/8	–	2 ¹³ / ₁₆	1 ⁹ / ₁₆	2 ¹ / ₄
GUV5825	250	2/0	3/4	5/8	3/8	–	2 ¹³ / ₁₆	1 ⁹ / ₁₆	2 ¹ / ₄
GUV784	#4	#8	1	7/8	3/4	1/2	2 ³ / ₄	1 ⁹ / ₁₆	2 ⁵ / ₈
GUV7821	2/0	#4	1	7/8	3/4	1/2	2 ³ / ₄	1 ⁹ / ₁₆	2 ⁵ / ₈
GUV7825	250	2/0	1	7/8	3/4	1/2	2 ³ / ₄	1 ⁹ / ₁₆	2 ⁵ / ₈
GUV1184	#4	#8	1 ¹ / ₄	1 ¹ / ₈	1	–	3 ⁵ / ₁₆	1 ⁹ / ₁₆	2 ³ / ₄
GUV11821	2/0	#4	1 ¹ / ₄	1 ¹ / ₈	1	–	3 ⁵ / ₁₆	1 ⁹ / ₁₆	2 ³ / ₄
GUV1384	#4	#8	1 ¹ / ₂	1 ³ / ₈	1 ¹ / ₄	–	3 ⁷ / ₁₆	1 ⁹ / ₁₆	2 ¹⁵ / ₁₆
GUV13821	2/0	#4	1 ¹ / ₂	1 ³ / ₈	1 ¹ / ₄	–	3 ⁷ / ₁₆	1 ⁹ / ₁₆	2 ¹⁵ / ₁₆
GUV13825	250	2/0	1 ¹ / ₂	1 ³ / ₈	1 ¹ / ₄	–	3 ⁷ / ₁₆	1 ⁹ / ₁₆	2 ¹⁵ / ₁₆
GUV1584	#4	#8	1 ⁷ / ₈	1 ⁵ / ₈	1 ¹ / ₂	–	3 ¹⁵ / ₁₆	1 ⁹ / ₁₆	3 ³ / ₁₆
GUV15821	2/0	#4	1 ⁷ / ₈	1 ⁵ / ₈	1 ¹ / ₂	–	3 ¹⁵ / ₁₆	1 ⁹ / ₁₆	3 ³ / ₁₆
GUV15825	250	2/0	1 ⁷ / ₈	1 ⁵ / ₈	1 ¹ / ₂	–	3 ¹⁵ / ₁₆	1 ⁹ / ₁₆	3 ³ / ₁₆
GUV204	#4	#8	2 ³ / ₈	2	2	–	4 ⁷ / ₁₆	1 ⁹ / ₁₆	3 ¹¹ / ₁₆
GUV2021	2/0	#4	2 ³ / ₈	2	2	–	4 ⁷ / ₁₆	1 ⁹ / ₁₆	3 ¹¹ / ₁₆
GUV2025	250	2/0	2 ³ / ₈	2	2	–	4 ⁷ / ₁₆	1 ⁹ / ₁₆	3 ¹¹ / ₁₆
GUV21221	2/0	#4	2 ⁷ / ₈	2 ¹ / ₂	2 ¹ / ₂	–	4 ¹⁵ / ₁₆	1 ⁹ / ₁₆	4 ³ / ₁₆
GUV21225	250	2/0	2 ⁷ / ₈	2 ¹ / ₂	2 ¹ / ₂	–	4 ¹⁵ / ₁₆	1 ⁹ / ₁₆	4 ³ / ₁₆
GUV3021	2/0	#4	3 ¹ / ₂	3	3	–	5 ⁹ / ₁₆	1 ⁹ / ₁₆	4 ¹³ / ₁₆
GUV3025	250	2/0	3 ¹ / ₂	3	3	–	5 ⁹ / ₁₆	1 ⁹ / ₁₆	4 ¹³ / ₁₆
GUV31221	2/0	#4	4	3 ¹ / ₂	3 ¹ / ₂	–	6 ¹ / ₁₆	1 ⁹ / ₁₆	5 ¹ / ₂
GUV4021	2/0	#4	4 ¹ / ₂	4	4	–	6 ⁵ / ₁₆	1 ⁹ / ₁₆	5 ¹¹ / ₁₆
GUV4025	250	2/0	4 ¹ / ₂	4	4	–	6 ⁵ / ₁₆	1 ⁹ / ₁₆	4 ¹³ / ₁₆

Diagrams

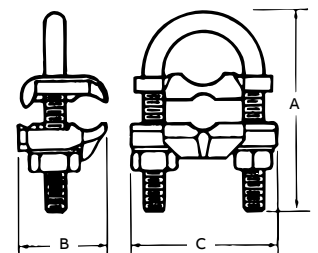

Clamps

Technical specifications

- 01 CI3106
- 02 CI3108
- 03 CI3110U
- 04 CI3112U
- 05 CIGRC58



01

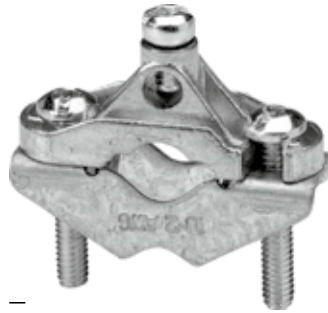

02



03



04



05



Cat. no.	Water pipe size (in.)	Ground wire size (AWG)		Ground rod size (in.)	
		Min.	Max.	Galv. steel	Copper clad
Ground clamps (zinc alloy body/steel screws)					
CI3106	½ to 1	#10 sol.	#2 str.	⅝ to 1*	—
Ground clamps (zinc/steel)					
CI3108	½ to 1	#10 sol.	#2 str.	⅝ to 1*	—
For connecting grounding conductor to either galvanized steel rod or water pipe.					
Ground clamps (brass body/brass screws)					
CI3110U	½ to 1	#10 sol.	#2 str.	⅝ to 1*	⅝ to 1
For connecting grounding conductor to either galvanized steel rod, copper clad or water pipe. CSA approved for wet locations and for direct burial.					
Ground clamps (brass body/brass screws)					
CI3112U	1¼ to 2	#10 sol.	#2 str.	—	—
For connecting grounding conductor to water pipe. CSA approved for wet locations and for direct burial.					
Ground rod clamps (bronze body/brass screws)					
CIGRC58	—	#10 sol.	#2 str.	⅝	⅝
CIGRC34	—	#8 sol.	1/0 str.	¾	¾

For connecting grounding conductor to either galvanized steel rod or copper clad rod.
CSA approved for wet locations and for direct burial.

*Reversible.

Clamps



Type GTC – Tower ground clamps

- Bolt has square shank to prevent turning and allow clamp to be tightened with one wrench
- GTC 23 and 24 are two-piece clamps for connecting ground lead cable to flat metal surface; ideal for grounding substations on tower footings

- Castings are of high-strength, corrosion-resistant copper alloy
- GTC 13 and 14 are economical one-piece clamps that perform the same function as two-piece clamps except the under-pad support is omitted and conductor is connected directly to tower
- Add suffix L to cat. no. for ½ in. channel thickness



Cat. no.	Conductor range				Channel thickness (in.)	Dimensions (in.)						
	Max. (AWG)	Min. (AWG)	Max. (mm ²)	Min. (mm ²)		A	B	D	E	G	H	R
GTC13	2/0 str.	#4 sol.	67.4	21.1	¼	1 ¹⁵ / ₃₂	–	¼ ₁₆	1 ²¹ / ₃₂	1 ¹³ / ₃₂	¾	7 ¹ / ₃₂
GTC14	250 kcmil	2/0 str.	126.6	67.4	¼	1 ¹⁵ / ₁₆	–	¾	1 ¹⁵ / ₁₆	1 ¹³ / ₃₂	½	5 ¹ / ₁₆
GTC23	2/0 str.	#4 sol.	67.4	21.1	¼	1 ⁴¹ / ₆₄	7 ¹ / ₁₆	¼ ₁₆	2 ²¹ / ₃₂	1 ³ / ₃₂	¾	–
GTC24	250 kcmil	2/0 str.	126.6	21.1	¼	1 ⁶¹ / ₆₄	5 ¹ / ₈	¾	1 ¹⁵ / ₁₆	1 ³ / ₈	½	–

Diagrams

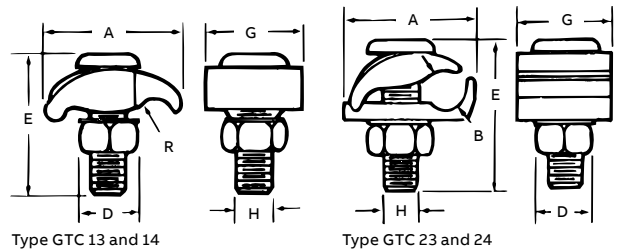

CTG250 – Wide range tower ground clamp

- For use with aluminum or copper conductors and in aluminum or galvanized steel cable tray
- Ribbed neck on the bolt prevents rotation during tightening if 0.440 in. dia. hole is used



Cat. no.	Wire range (2 sides) (AWG or kcmil)	Height (in.)	Width (in.)	Depth (in.)	Nut (flats) (in.)
CTG250	#2 sol. (0.258 in. Dia.), 250 (0.575 in. Dia.)	1.95	2.00	1.13	0.560

Diagram

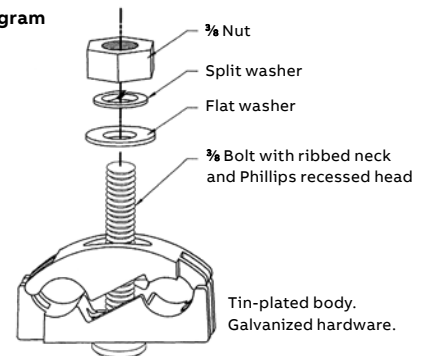

Clamps



I-beam ground clamps

Connect ground cable to I-beam or any 1 in. maximum structural steel member – without welding or drilling.

- Breakaway bolt head shears at predetermined torque to ensure tight connection
- Heavy-duty compression lug provides excellent current-carrying capabilities
- Surface of steel must be cleaned in accordance with installation instruction sheet provided with product
- Connector made of high-conductivity cast copper bright dip
- Clamp made of drop-forged high-grade steel, zinc-plated



Cat. no.	Wire range (AWG or kcmil)	TBM15I, TBM15 Installing tool, die code	Die cat. no.	Number of crimps
IBG2-10	#2-1/0	66H	15534SS	2
IBG20-40	2/0-4/0	76H	15512SS	2
IBG350-500	350-500	115H	15504SS	2

Hydraulic tooling with hex crimp dies.
Use 15500TB adaptor for TBM15I 15-ton tool.



Ground clamps

For permanent, reliable connection.

- Crimp to cable
- Clamp to ground rod and rebar
- Use standard Color-Keyed hand and hydraulic tools
- Colour-coded for easy installation die selection
- Made from high-conductivity wrought copper
- Furnished with stainless steel hardware, ¼ in. washers, bolts and nuts



Cat. no.	Wire size (AWG)	Ground rod diameter (in.)	Rebar (in.)	Bolt size (in.)	Die code and colour
CC2C-45R	#2-#3	½ or ⅝	0.80	0.25	33 Brown
CC1C-45R	#1	½ or ⅝	0.80	0.25	37 Green
CC10C-56R	1/0	⅝ or ¾	0.83	0.38	42 Pink
CC20C-56R	2/0	⅝ or ¾	0.83	0.38	45 Black
CC40C-56R	4/0	⅝ or ¾	0.83	0.38	54 Purple

UL Approved for direct burial.

Clamps



Flat-surface ground clamps

Terminate or connect continuous runs of copper cable to flat surfaces.

- Captive “keeper bar” design extends cable range and helps hold cable prior to crimping, facilitating installation
- Saddles marked with conductor size and die code
- Conductor can be assembled to saddle with standard dies and hydraulic tools
- Made from high-conductivity cast copper



Cat. no.	Wire range (AWG or kcmil)	Bolt hole (in.)	Die code no.	Qty.	Std. pkg.	Wt. per 100	Hex die		Dimensions in. (mm)				
							Cat. no.	Die code no.	L1	L2	D	C	H
53055FL	1/0–2/0 AWG	3/8	66	2	10	75	15534*	66	4.09 (103.9)	3.66 (93.0)	0.28 (7.1)	1.38 (35.1)	1.00 (25.4)
53065FL	4/0–250 kcmil	3/8	87H	2	10	112	15506**	87H	4.50 (114.3)	4.09 (103.9)	0.31 (7.9)	1.38 (35.1)	1.00 (25.4)

Diagram

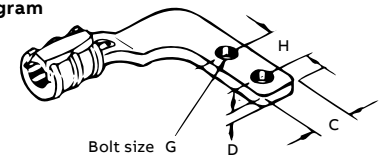

* TBM14M, 13100A, TBM15I with hex crimp dies.
 ** TBM15I with hex crimp dies only.



Grid-to-fence ground clamps

Bond copper conductors to steel or aluminum fence post or top rail of round fence posts.

- Provide quick, dependable installation at low installed cost
- Use no incendiary materials
- Body made from cast copper alloy with steel U-bolt



Cat. no.	Ground cable range (AWG)	Die code	Steel and aluminum line post range (in)
FG2040R2	2/0–3/0–4/0	76	2.00
FG2040R25	2/0–3/0–4/0	76	2.50
FG2040R3	2/0–3/0–4/0	76	3.00
FG210R2	#2–#1–1/0	66	2.00
FG210R25	#2–#1–1/0	66	2.50
FG210F3	#2–#1–1/0	66	3.00

Diagram

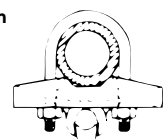

Install with hydraulic tooling with hex crimp dies.