

Fittings and accessories

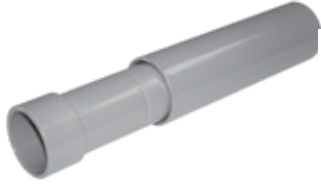

Coupling end



Male terminal adapter end

Expansion fittings*

E945 series expansion fittings are designed to compensate for length changes due to temperature variations in exposed conduit runs.

- Exclusive molded-in mid-point indicator on the piston
- Exclusive 2 in. expansion fitting with an 8 in. travel distance
- Two-piece molded design with lubricated seals for easier movement for the life of the product
- Ridges on the fitting for easier installation (sizes 2 in. through 6 in. only)
- Male terminal adapter end design (½ in. – 2 in. NPT threads and 2½ in. – 6 in. NPSC threads)
- Two O-rings to prevent leakage
- Can be installed vertically or horizontally



Coupling end cat. no.	Male terminal adapter end cat. no.	Size (in.)	Std. ctn. qty.	Travel length (in.)
E945D	E945DX	½	20	4
E945E	E945EX	¾	15	4
E945F	E945FX	1	10	4
E945G	E945GX	1¼	5	4
E945H	E945HX	1½	5	4
E945J	E945JX	2	15	8
E945K	E945KX	2½	10	8
E945L	E945LX	3	10	8
E945M	E945MX	3½	5	8
E945N	E945NX	4	5	8
E945P	E945PX	5	1	8
E945R	E945RX	6	1	8

* Please refer to [page 30](#) for additional information.



Socket type for joining nonmetallic conduit.

Standard couplings

All socket fittings should be attached using Carlon solvent cement. Using Carlon fittings with Carlon nonmetallic conduit ensures system integrity.



Cat. no.	Size (in.)	Std. ctn. qty.	Typical (in.)		I.D. (in.)	O.D. (in.)	Typical (in.)	
			A	B			C	L
CE940DR-CTN	½	75	0.852	0.836	0.728	1 ⁷ / ₆₄	1 ¹¹ / ₁₆	1½
CE940ER-CTN	¾	45	1.064	1.046	0.840	1 ⁵ / ₁₆	¾	1½
CE940F-UPC	1	50	1.330	1.310	1.210	1 ⁵ / ₈	1 ¹ / ₁₆	2
E940G	1¼	30	1.677	1.655	1.535	1 ⁶³ / ₆₄	1	2½
E940H	1½	25	1.918	1.894	1.755	2 ¹⁵ / ₆₄	1 ¹ / ₈	2½
E940J	2	30	2.393	2.369	2.190	2 ⁴⁷ / ₆₄	1 ³ / ₁₆	2½
E940K	2½	20	2.890	2.868	2.688	3 ⁵ / ₁₆	1 ³³ / ₆₄	3½
E940L	3	25	3.515	3.492	3.375	3 ³³ / ₃₂	1¾	3 ¹³ / ₃₂
E940M	3½	20	4.015	3.992	3.780	4 ⁹ / ₁₆	1¾	3½
E940N	4	15	4.515	4.491	4.265	5 ³ / ₃₂	1 ²⁵ / ₃₂	3¾
E940P	5	8	5.593	5.553	5.097	6¼	1 ¹⁵ / ₁₆	4½
E940R	6	5	6.658	6.614	6.115	7½	2 ³ / ₁₆	4½

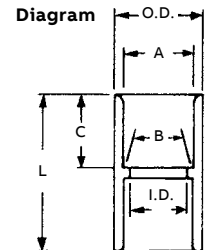

Short expansion couplings*

(Expands to a maximum of 2 in.)



Cat. no.	Size (in.)	Std. ctn. qty.
E955D	½	40
E955E	¾	40
E955F	1	25
E955G	1¼	15
E955H	1½	10
E955J	2	6

* Please refer to [page 30](#) for additional information.

Fittings and accessories



Female adapters

For adapting nonmetallic conduit to threaded fittings, metallic systems. Female threads on one end, socket end on other.



Male terminal adapters

For adapting nonmetallic conduit to boxes threaded fittings, metallic systems. Male threads on one end, socket end on other.

Cat. no.	Size (in.)	Std. ctn. qty.	Typical (in.)		Min. I.D. (in.)	Max. O.D. (in.)	Typical (in.)		
			A	B			C	T	L
E942D	1/2	150	0.852	0.836	0.620	1 1/64	1 1/16	3/4	1 9/16
E942E	3/4	100	1.064	1.046	0.822	1 1/16	1 3/16	3/4	1 9/16
E942F	1	50	1.330	1.310	1.046	1 5/8	1 5/16	7/8	1 15/16
E942G	1 1/4	30	1.677	1.655	1.377	1 63/64	1	7/8	2
E942H	1 1/2	25	1.918	1.894	1.607	2 5/32	1 1/8	7/8	2 7/32
E942J	2	30	2.393	2.369	2.064	2 47/64	1 3/16	1	2 5/16
E942K	2 1/2	20	2.890	2.868	2.450	3 11/32	1 5/8	1 1/8	2 15/16
E942L	3	25	3.515	3.492	3.000	3 31/32	1 3/4	1 1/8	3 1/16
E942M	3 1/2	20	4.015	3.992	3.500	4 1/2	1 7/8	1 1/8	3 3/4
E942N	4	15	4.515	4.491	4.000	5 1/64	1 3/4	1 1/16	3 13/64
E942P	5	8	5.593	5.553	5.047	6 1/4	1 15/16	1 1/16	3 3/16
E942R	6	6	6.658	6.614	6.055	7 1/4	2 1/8	1 1/16	3 3/8

Cat. no.	Size (in.)	Std. ctn. qty.	Typical (in.)		Min. D. (in.)	Max. O.D. (in.)	Typical (in.)		
			A	B			C	S	L
E943D	1/2	150	0.852	0.836	0.594	1.042	0.652	0.545	1.310
E943E	3/4	100	1.064	1.046	0.793	1.290	0.809	0.553	1.470
E943F	1	50	1.330	1.310	1.025	1.580	0.965	0.812	1.902
E943G	1 1/4	30	1.677	1.655	1.345	1.973	1.208	0.816	1.986
E943H	1 1/2	25	1.918	1.894	1.574	2.188	1.155	0.802	2.105
E943J	2	30	2.393	2.369	1.998	2.713	1.145	0.825	2.093
E943K	2 1/2	20	2.890	2.868	2.400	3.290	1.490	0.812	2.480
E943L	3	25	3.515	3.492	2.989	3.965	1.643	0.797	2.660
E943M	3 1/2	20	4.015	3.992	3.405	4.515	1.720	0.802	2.740
E943N	4	15	4.515	4.491	3.895	5.065	1.788	0.733	2.830
E943P	5	8	5.593	5.553	4.900	6.104	1.935	0.990	3.200
E943R	6	6	6.658	6.614	5.900	7.288	2.128	0.985	3.410

Diagram

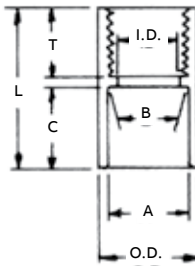

Diagram

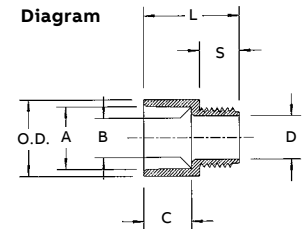

Fittings and accessories



Reducer bushings

For connecting different sizes of conduit. Bell x spigot.

Cat. no.	Size (in.)	Std. ctn. qty.	Typical (in.)		
			L	A	C
E950ED	¾ x ½	100	1 ⁵ / ₃₂	1 ³ / ₆₄	1 ¹ / ₃₂
E950FD-CAR	1 x ½	25	1 ¹¹ / ₃₂	3 ¹ / ₁₆	5 ⁷ / ₆₄
E950FE	1 x ¾	100	1 ¹¹ / ₃₂	3 ¹ / ₁₆	1 ¹ / ₆₄
E950GE-CAR	1¼ x ¾	10	1 ¹⁵ / ₃₂	3 ¹ / ₁₆	1 ¹ / ₆₄
E950GF	1¼ x 1	50	1 ¹⁵ / ₃₂	3 ¹ / ₁₆	1 ⁹ / ₆₄
E950HF-CAR	1½ x 1	10	1 ¹⁹ / ₃₂	3 ¹ / ₁₆	1 ⁹ / ₆₄
E950HG-CAR	1½ x 1¼	10	1 ¹⁹ / ₃₂	3 ¹ / ₁₆	1 ¹⁷ / ₆₄
E950JG-CAR	2 x 1¼	10	1¾	7 ¹ / ₃₂	1 ¹⁷ / ₆₄
E950JH-CAR	2 x 1½	10	1¾	7 ¹ / ₃₂	1 ²⁵ / ₆₄
E950KJ-CAR	2½ x 2	10	2 ⁵ / ₃₂	3 ³ / ₈	1 ²⁷ / ₆₄
E950LJ-CAR	3 x 2	10	2½	¾	1 ⁷ / ₈
E950LK	3 x 2½	25	1 ¹⁵ / ₁₆	¾	1 ¹¹ / ₁₆
E950NL	4 x 3	25	2¾	5 ¹ / ₁₆	1 ¹⁵ / ₁₆

Diagram

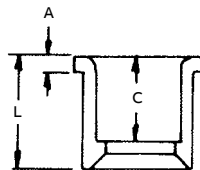

Box adapters for enclosures

Adapts nonmetallic conduit to all electrical enclosures by inserting adapter through knockout and cementing into Carlon couplings.

Cat. no.	Size (in.)	Std. ctn. qty.	Min. D (in.)	O.D. typical (in.)	Max. X (in.)	Typical (in.)	
						CM	L
E996D	½	100	0.662	0.840	1 ⁷ / ₆₄	2 ³ / ₃₂	2 ⁷ / ₃₂
E996E	¾	100	0.824	1.050	1 ²¹ / ₆₄	2 ⁵ / ₃₂	2 ⁹ / ₃₂
E996F	1	100	1.049	1.315	1 ⁵ / ₈	6 ¹ / ₆₄	1 ³ / ₃₂
E996G	1¼	50	1.380	1.660	1 ³¹ / ₃₂	1 ¹ / ₁₆	1¼
E996H	1½	50	1.610	1.900	2 ¹³ / ₆₄	1 ³ / ₁₆	1 ³ / ₈
E996J	2	25	2.067	2.375	2 ²⁹ / ₃₂	1¼	1 ⁷ / ₁₆
E996K	2½	15	2.469	2.875	3 ⁷ / ₁₆	1 ⁷ / ₈	1 ¹⁵ / ₁₆
E996L	3	20	3.068	3.500	4 ¹ / ₈	2	2 ¹ / ₁₆
E996N	4	10	4.026	4.500	5 ¹ / ₈	2½	2¾

Diagram

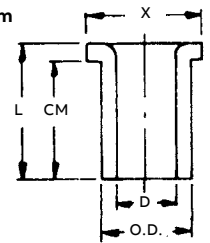

Threaded adapters

Cat. no.	Size (in.)	Std. ctn. qty.
E9842D 1	½	25
E9842E 2	¾	25

1 Fits ¾ in. sockets

2 Fits 1 in. sockets



Plugs with pull tabs (polyethylene)

Cat. no.	Size (in.)	Std. ctn. qty.	Std. ctn. wt. (lb)
P258JT	2	60	3
P258LT	3	30	3
P258NT	4	48	8
P258PT	5	30	6
P258RT	6	30	9

Fittings and accessories

Service entrance caps



Cat. no.	Size (in.)	Std. ctn. qty.	Dimensions (in.)			
			E	F	G	H
E998D	½	5	1.76	0.45	0.45	-
E998E	¾	20	1.76	0.45	0.45	-
E998F	1	15	2.26	0.59	0.58	-
E998G	1¼	20	3.52	0.74	0.71	0.50
E998H	1½	10	3.52	0.74	0.71	0.50
E998J	2	5	4.26	0.83	0.78	0.56
E998K-UPC	2½	2	7.47	1.70	1.31	1.00
E998L	3	2	7.47	1.70	1.31	1.00
E998N	4	2	10.45	2.25	1.88	1.31



Diagrams

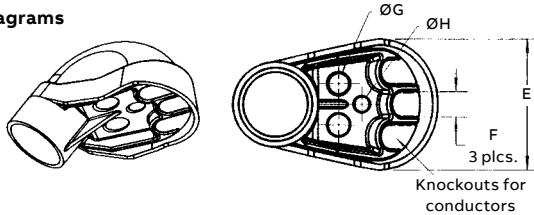

End caps

Cat. no.	Size (in.)	Std. ctn. qty.	Std. ctn. wt. (lb)
E958D	½	100	3
E958E	¾	100	4
E958F	1	75	5
E958G	1¼	40	4
E958H	1½	30	4
E958J	2	25	5
E958K	2½	10	4
E958L	3	10	5
E958N	4	5	17
E958P	5	5	11
E958R	6	5	13



Meter hubs

Cat. no.	Size (in.)	Std. ctn. qty.	Std. ctn. wt. (lb)
E991G	1¼	20	3.8
E991G-UPC	1¼	12	2.3
E991H	1½	25	8.0
E991J	2	6	1.0
E991J-UPC	2	12	2.0



Meter offset

Cat. no.	Size (in.)	Std. ctn. qty.	Offset (in.)	A (in.)
E995G	1¼	15	0.758	4.230
E995J	2	8	0.684	4.270

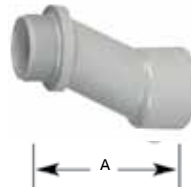

Offset

Cat. no.	Size (in.)	Std. ctn. qty.	Std. ctn. wt. (lb)
E994D	½	25	3
E994E	¾	25	3
E994F	1	50	12



End bells



Cat. no.	Size (in.)	Std. ctn. qty.	Std. ctn. wt. (lb)
E997F	1	50	2.6
E997G	1¼	35	2.5
E997H	1½	30	2.5
E997J	2	40	5.0
E997K	2½	30	2
E997L	3	50	10
E997M	3½	40	11
E997N	4	30	16
E997P	5	15	8
E997R	6	10	7
E997T	8	3	15



Fittings and accessories



Flat sealing washer

Where a waterproof termination is required into any enclosure (metallic or nonmetallic), install the neoprene washer over the threads of a terminal adapter before inserting into the enclosure. Use a standard locknut or threaded bushing to secure the assembly.

Cat. no.	Size (in.)	Std. ctn. qty.
E943DW	½	125
E943EW	¾	125
E943FW	1	100
E943GW	1¼	50
E943HW	1½	50
E943JW	2	25



Holform™ concrete sleeves

Holform nonmetallic concrete sleeve forms are the easy way to form holes in concrete. They install in seconds with nails, screws or staples and are easily removed. Concrete will not adhere to them. Holform are adjustable to any slab thickness. (Not CSA applicable)

Cat. no.	Min. O.D. A (in.)	B (in.)	Std. ctn. qty.	Std. ctn. wt. (lb)
E92CSH	1½	1¾	20	3
E92CSJ	2	2 ¹³ / ₃₂	25	6
E92CSL	3	3 ¹³ / ₃₂	25	8
E92CSN	4	4 ¹³ / ₃₂	18	8
E92CSP	5	5 ¹³ / ₃₂	15	8
E92CSR	6	6 ¹³ / ₃₂	12	8

Diagram

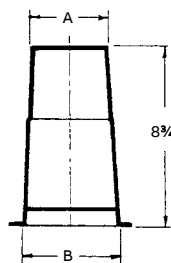

Conduit bodies type x with cover

Four knockout type socket openings, 90° spacing. Available with ½ in. or ¾ in. socket outlets. Includes cover and gasket.



Cat. no.	Size (in.)	Vol. (cu. in.)	Std. ctn. qty.
CE970CDE	½	15.16	15
E970CE	¾	15.16	15

Diagrams

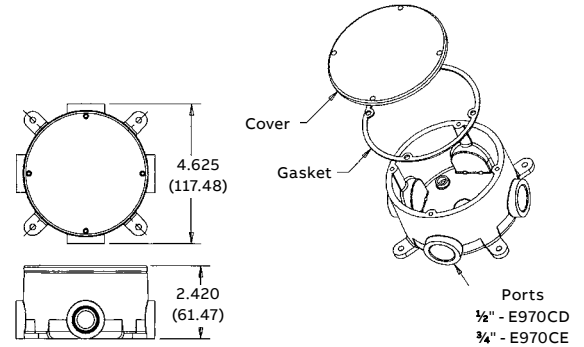

Supplied with 4 stainless steel cover screws. Diameter 4¹/₈ in., Thickness ¼ in. Not designed for use with wiring devices or light fixtures.



Access pull elbows



Cat. no.	Size (in.)	Std. ctn. qty.	Typical (in.)			
			A	B	C	D
E990D	½	75	0.852	0.836	2.187	0.718
E990DR-CAR	½	25	0.852	0.836	2.187	0.718
E990E	¾	50	1.064	1.046	2.531	0.781

Diagram

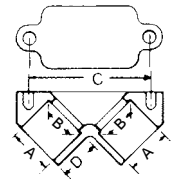

Gasket included