

Accessories

Wall termination / universal blind end

Support and terminate runs of cable tray with this wall termination angle. Can be used as a wall support, floor-to-ceiling support or to safely terminate any tray run. Adapts to any configuration and any width.

Available in pregalvanized steel. Mounting hardware sold separately.

Express tip: Refer to page C52 for an application example.
Tool required: 10 mm nut driver



Diagrams

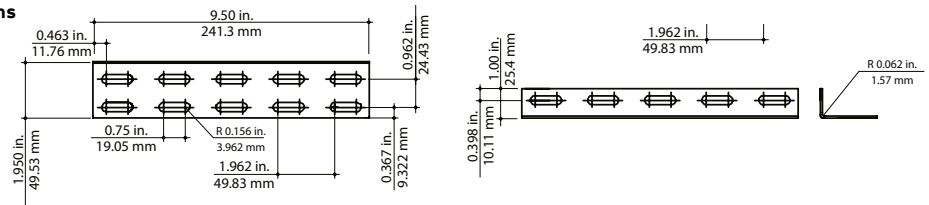

Cat no.	Material	lb/ea.	Weight kg/ea.
ETA-WTA-PG	Pregalvanized steel	0.36	0.17

90-degree bracket

Create high strength tee, cross and other 90-degree configurations with this 90-degree bracket. Available in hot-dipped galvanized steel either as a single bracket or a kit.

Kit includes one (1) bracket, four (4) bracket clamps and one (1) hot-dipped galvanized universal splice.

Express tip: Refer to page C44 for an application example.
Tool required: 10 mm nut driver



Diagram

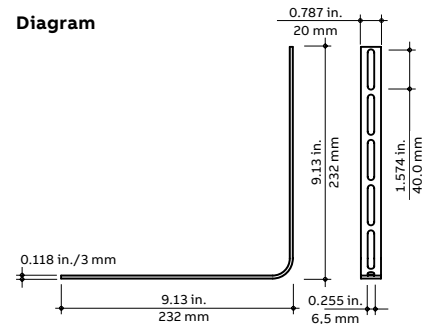

Cat no.	Material	lb/ea.	Weight kg/ea.
ETA-H90-HD	Single 90-degree bracket	0.51	0.23
ETA-H90KIT-HD	90-degree bracket kit*	0.69	0.31

* Kit includes — (1) 90° bracket (ETA-H90-HD), 4 bracket clamps (ETH-WBC-HD) and 1 universal splice (ETH-SP-HD)

Accessories

Cable drop-out

This 2 in. radius cable drop-out protects cables when exiting or entering tray by reducing the strain on the cables. The drop-out attaches to tray with built-in tabs. No hardware is required.

Three different widths available in pregalvanized steel. This drop-out is suitable for use with all tray widths and heights.

Express tip: Refer to page C45 for an application example.



Cat no.	Material	Width (W)		Weight	
		in.	mm	lb/ea.	kg/ea.
ETA-CDOU17-PG	Pregalvanized steel	1.75	45	0.16	0.07
ETA-CDOU35-PG		3.50	90	0.31	0.14
ETA-CDOU52-PG		5.25	135	0.49	0.22

Diagrams

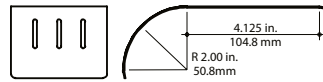
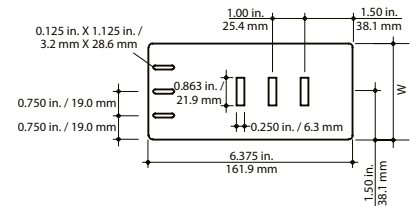

Diagram shows a 3.5 in. drop-out.



Large cable drop-out

For larger cable tray widths and heavier cable loading, use the 7 in. radius large cable drop-out to protect cable exiting or entering tray runs. Available in pregalvanized steel, the large cable drop-out has a versatile slotted design that enables the use of Ty-Rap® cable ties to attach the cable bundles to the drop-out.

Use built-in tabs to attach to siderails or universal clamp (see page C27) to attach to the end of cable runs.

Express tip: Refer to page C45 for an application example.



Cat no.	Material	Weight	
		lb/ea.	kg/ea.
ETA-CDOUL-PG	Pregalvanized steel	0.90	0.40

Diagrams

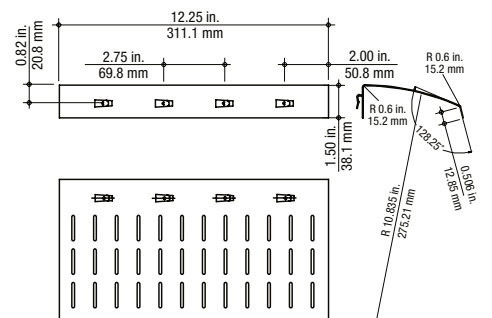

Accessories

Side hanger clamp

The side hanger clamp is used to construct trapeze supports using threaded rods. The offset support hole allows for trouble-free access to support nuts for height adjustment, and the rod can continue downward to allow for multi-level (tiered) trapeze installations.

A set screw holds tray firmly in position once installation is complete. Available in pregalvanized steel. For use with 3/8 in. threaded rod.

Express tip: Refer to page C49 for an application example.



Cat no.	Material	lb/ea.	Weight kg/ea.
ETH-SH-PG	Pregalvanized steel	0.13	0.06
ETH-SH-HD	Hot-dipped galvanized steel	0.13	0.06
ETH-SH-S6	Stainless steel (type 316)	0.13	0.06

Diagrams

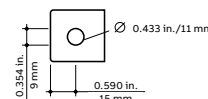
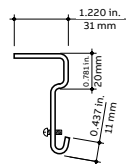
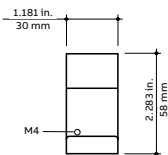

Universal clamp

The universal clamp is used to secure large cable drop-outs to the end of a cable run as well as attaching bottom inserts to lengths of ExpressTray.

Express tip: Refer to pages C45–C46 for application examples.

Note: To hold down 2 in. x 2 in. wire basket tray, use 1 ETH-UNIVC-XX with bottom half of ETH-SP-XX. See page C16.



Cat no.	Material	lb/ea.	Weight kg/ea.
ETH-UNIVC-PG	Pregalvanized steel	0.09	0.04
ETH-UNIVC-HD	Hot-dipped galvanized steel	0.09	0.04
ETH-UNIVC-S6	Stainless steel (type 316)	0.09	0.04

Diagram

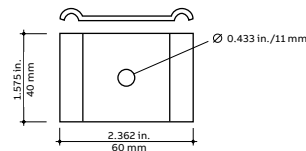

Wall clamp

This wall clamp attaches the flange of U- and C-profile ExpressTray, up to a maximum of 8 in. wide, to the wall surface.

Available in pregalvanized steel and stainless steel.

Express tip: Refer to page C52 for application examples.



Cat no.	Material	lb/ea.	Weight kg/ea.
ETH-WC-PG	Pregalvanized steel	0.18	0.08
ETH-WC-SS	Stainless steel (type 304)	0.18	0.08

Diagrams

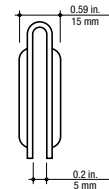
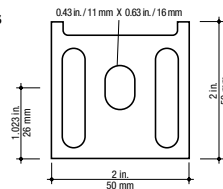

Accessories

Threaded rod clamp

This clamp is used for center-hung applications to secure tray sections to threaded rod for ceiling mounting and can be used with U-profile tray in 4 in., 8 in. and 12 in. widths. This clamp is not designed for use with C-profile tray.

Available in pregalvanized steel, hot-dipped galvanized steel and stainless steel (type 316). For use with 3/8 in. threaded rod.

Express tip: Refer to page C48 for an application example.

	Cat no.	Material	Weight	
			lb/ea.	kg/ea.
	ETH-CHC-PG	Pregalvanized steel	0.18	0.08
	ETH-CHC-HD	Hot-dipped galvanized steel	0.18	0.08

Diagrams

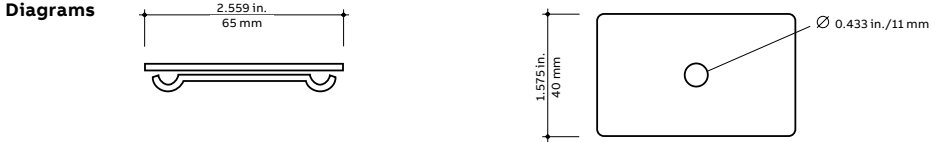

Superstrut® threaded rod

Used for overhead mounting of ExpressTray with threaded rod clamp, side hanger clamps or strut.

Available in 1/4 in. and 3/8 in. diameters, threaded rods are made of electro-galvanized steel.

Express tip: Refer to pages C47–C49 for application examples. Order nut and washer separately. (See page C34).

	Cat no.	Thread per in.	Size (D) (in.)	Weight	
				lb/ea.	kg/ea.
	H104-1/4X10EGC	20	1/4	2.7	1.22
	H104-3/8X10EGC	16	3/8	2.9	1.32

Diagram

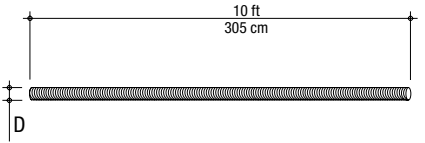

Superstrut metal framing channel

Superstrut metal framing channel is sold in 10-foot lengths and the standard finish is pregalvanized steel.

Various finishes and configurations are available, contact your regional sales office for further information.

	Cat no.	Material	Weight	
			lb/ea.	kg/ea.
	D120010PG	Pregalvanized steel	7.28	3.30

Diagram

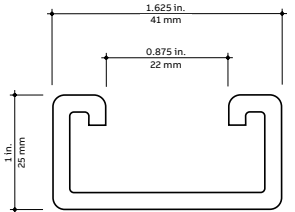

Accessories

Barrier strip

Used to separate bundles of power, communication and data cables. Barrier strips are sold in standard 10-foot lengths and are available in 1¾ in. and 3¾ in. heights. Available in pregalvanized steel, hot-dipped galvanized and stainless steel (types 304 and 316).

For use with barrier strip connector and barrier strip clamp, both sold separately on pages C29 and 30. Each 10 foot barrier strip should be secured by three barrier strip clamps one on each end and one in the middle.

Express tip: Refer to page C55 for an application example.

Cat no.	Material	Height (H)		Weight	
		in.	mm	lb/ea.	kg/ea.
ET-BS175-PG	Pregalvanized steel	1.750	45	3.15	1.40
ET-BS175-HD	Hot-dipped galvanized steel	1.750	45	3.30	1.40
ET-BS175-SS	Stainless steel (type 304)	1.750	45	1.03	0.468
ET-BS175-S6	Stainless steel (type 316)	1.750	45	1.03	0.468
ET-BS338-PG	Pregalvanized steel	3.375	85	3.15	2.11
ET-BS338-HD	Hot-dipped galvanized steel	3.375	85	3.15	2.11
ET-BS338-SS	Stainless steel (type 304)	3.375	85	3.15	2.11



Diagrams

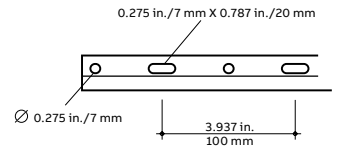
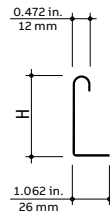

Barrier strip connector

This connector is used to connect lengths of barrier strips.

Available in two sizes for use with 1¾ in. and 3¾ in. barrier strips.

Cat no.	Material	lb/ea.	Weight
			kg/ea.
ET-BSH-UNIV-SS	Stainless steel	0.02	0.01



Diagrams

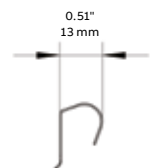
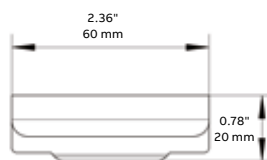

Accessories

Barrier strip clamp

The barrier strip clamp is used to mount barrier strips to ExpressTray profiles.

Available in electro-galvanized steel, hot-dipped galvanized steel and stainless steel (types 304 and 316).

Express tip: Refer to page C55 for an application example.



Cat no.	Material	lb/ea.	Weight
			kg/ea.
ETH-BSC-EG	Electro-galvanized steel	0.04	0.02
ETH-BSC-HD	Hot-dipped galvanized steel	0.04	0.02
ETH-BSC-SS	Stainless steel (Type 304)	0.04	0.02
ETH-BSC-S6	Stainless steel (Type 316)	0.04	0.02

Diagram

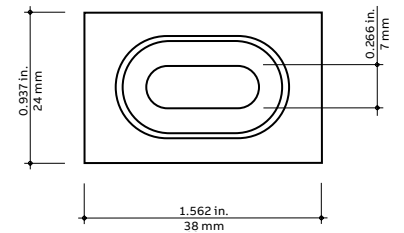

Cover and bottom insert

ExpressTray covers and bottom inserts protect cables from dust build-up and provide a physical barrier in environments where cables must be protected from machinery or vandalism. Attach bottoms to tray using universal clamps (see page C27) and secure covers using cover clips (see page C32).

Available in pregalvanized steel in widths from 2 in. to 24 in. Available in lengths of 120 in. or 40 in. Available in solid or vented design.

Express tip: Refer to page C46 for an application example.

Cover and bottom insert

	Width (W)		Cat no. covers	Weight		Cat no. bottoms	Weight	
	in.	mm		lb/ea.	kg/ea.		lb/ea.	kg/ea.
ETACOVS**PG-120	Solid covers and bottoms 120 in. (3 m) length (L)							
	2	50	ETACOVS02PG-120	1.59	0.72	ETABIS02PG-120	1.51	0.68
	4	100	ETACOVS04PG-120	2.03	0.92	ETABIS04PG-120	1.93	0.87
	6	150	ETACOVS06PG-120	2.45	1.11	ETABIS06PG-120	2.33	1.05
	8	200	ETACOVS08PG-120	4.19	1.90	ETABIS08PG-120	3.98	1.81
	12	300	ETACOVS12PG-120	5.91	2.68	ETABIS12PG-120	5.61	2.55
	16	400	ETACOVS16PG-120	7.65	3.47	ETABIS16PG-120	7.27	3.30
	18	450	ETACOVS18PG-120	8.42	3.82	ETABIS18PG-120	8.00	3.63
	20	500	ETACOVS20PG-120	9.39	4.26	ETABIS20PG-120	8.92	4.05
	24	600	ETACOVS24PG-120	11.11	5.04	ETABIS24PG-120	10.55	4.79



Diagrams

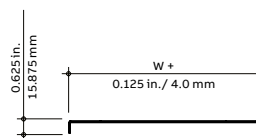

Solid bottom insert

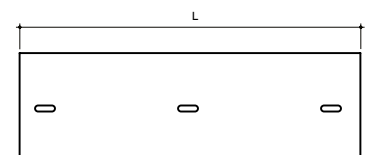

Accessories

Cover and bottom insert – continued



Width (W)		Cat no. covers	Weight		Cat no. bottoms	Weight	
in.	mm		lb/ea.	kg/ea.		lb/ea.	kg/ea.
Solid covers and bottoms 40 in. (1 m) length (L)							
2	50	ETACOVSO2PG-40	0.53	0.24	ETABISO2PG-40	0.50	0.23
4	100	ETACOVSO4PG-40	0.68	0.31	ETABISO4PG-40	0.64	0.29
6	150	ETACOVSO6PG-40	0.82	0.37	ETABISO6PG-40	0.78	0.35
8	200	ETACOVSO8PG-40	1.40	0.63	ETABISO8PG-40	1.33	0.60
12	300	ETACOVSI2PG-40	1.97	0.89	ETABIS12PG-40	1.87	0.85
16	400	ETACOVSI6PG-40	2.55	1.16	ETABIS16PG-40	2.42	1.10
18	450	ETACOVSI8PG-40	2.81	1.27	ETABIS18PG-40	2.67	1.21
20	500	ETACOVSI20PG-40	3.13	1.42	ETABIS20PG-40	2.97	1.35
24	600	ETACOVSI24PG-40	3.70	1.68	ETABIS24PG-40	3.52	1.6
Vented covers and bottoms 120 in. (3 m) length (L)							
2	50	ETACOVV02PG-120	1.54	0.70	ETABIV02PG-120	1.47	0.66
4	100	ETACOVV04PG-120	1.97	0.89	ETABIV04PG-120	1.87	0.85
6	150	ETACOVV06PG-120	2.38	1.08	ETABIV06PG-120	2.26	1.02
8	200	ETACOVV08PG-120	4.06	1.84	ETABIV08PG-120	3.86	1.75
12	300	ETACOVV12PG-120	5.73	2.60	ETABIV12PG-120	5.45	2.47
16	400	ETACOVV16PG-120	7.42	3.37	ETABIV16PG-120	7.05	3.20
18	450	ETACOVV18PG-120	8.17	3.71	ETABIV18PG-120	7.76	3.52
20	500	ETACOVV20PG-120	9.11	4.13	ETABIV20PG-120	8.65	3.93
24	600	ETACOVV24PG-120	10.78	4.89	ETABIV24PG-120	10.24	4.64
Vented covers and bottoms 40 in. (1 m) length (L)							
2	50	ETACOVV02PG-40	0.51	0.23	ETABIV02PG-40	0.49	0.22
4	100	ETACOVV04PG-40	0.66	0.30	ETABIV04PG-40	0.62	0.28
6	150	ETACOVV06PG-40	0.79	0.36	ETABIV06PG-40	0.75	0.34
8	200	ETACOVV08PG-40	1.35	0.61	ETABIV08PG-40	1.29	0.58
12	300	ETACOVV12PG-40	1.91	0.87	ETABIV12PG-40	1.82	0.82
16	400	ETACOVV16PG-40	2.47	1.12	ETABIV16PG-40	2.35	1.07
18	450	ETACOVV18PG-40	2.72	1.24	ETABIV18PG-40	2.59	1.17
20	500	ETACOVV20PG-40	3.04	1.38	ETABIV20PG-40	2.88	1.31
24	600	ETACOVV24PG-40	3.59	1.63	ETABIV24PG-40	3.41	1.55

Diagrams

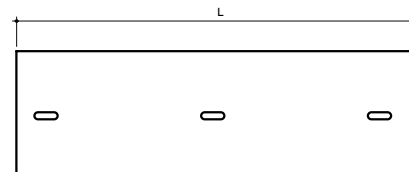
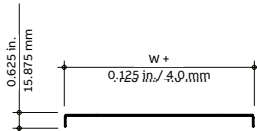

Accessories

Cover clip

Secure covers to tray quickly with this cover clip. Available in stainless steel (type 301), the cover clip uses built-in tabs to secure the cover and to

facilitate removal of the cover when required. No tools required.

Express tip: Refer to page C46 for an application example.

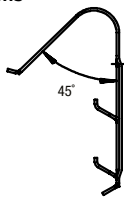
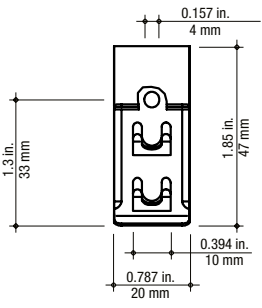
	Cat no.	Material	lb/ea.	Weight kg/ea.
	ETA-CC-S6	Stainless steel (type 301)	0.10	0.008
Diagrams				
				
				

Blackburn grounding connector

Note: To ensure electrical continuity, the Blackburn GPT-2 grounding connector and ground wire MUST be used in all Quiklok series tray applications. The GPT-2 grounding connector is used for bonding applications not exceeding 300 A (as per Table 16 of CEC) and is ideal for conductors #14 to #4 AWG.

For applications requiring larger conductors, contact your regional sales office for further information.

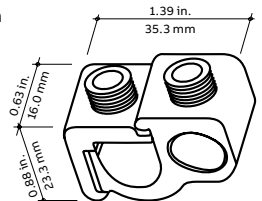

	Cat no.	Conductor range (AWG)	lb/ea.	Weight kg/ea.
	GPT-2	#14-#4	0.06	0.03
Diagram				
				

Accessories



ETG lay-in ground lug

- Lay-in lug design easily installs onto any ExpressTray 2 in. through 4 in. deep without any disassembly required
- Approved for steel and stainless steel wire mesh trays
- Accepts 12 AWG solid through 2 AWG stranded aluminum and 14 AWG solid/stranded through 2 AWG stranded copper conductors
- “Slotted hook” design sits securely onto the ExpressTray mesh intersections to restrict swiveling
- Must be used on each length of QuikLok series tray applications to meet CSA requirements

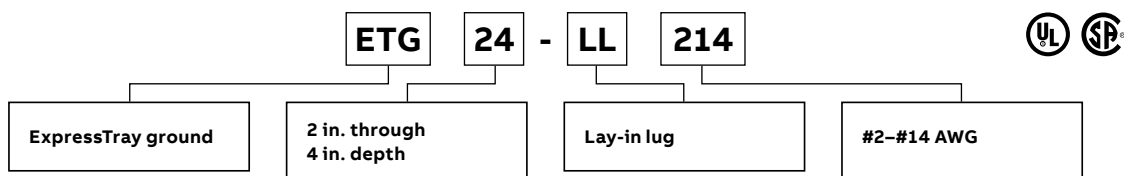

Superstrut “BAT” clip

Attaches ExpressTray to strut

- One-piece construction
- No installation tools required
- Reduces installation time to the minimum
- For horizontal applications

Cat no.	Material	Weight	
		lb/ea.	kg/ea.
SSF-CK535	Spring steel with zinc phosphate finish (black)	1.20	0.55

Note: “BAT” clip should be used for horizontal tray/strut applications. For vertical tray/strut applications, the universal clamp (page C27) should be used to clamp ExpressTray to strut using a bolt and spring nut (page C35).

- 01 Position “BAT” clip on outer wires of tray and opposing sides of the strut flanges.
- 02 To install, just hook one wing under the strut flange and push down the other wing with your thumb to slip it under the strut flange.

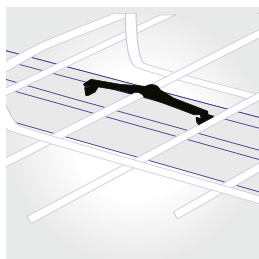

— 01

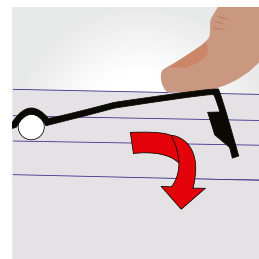
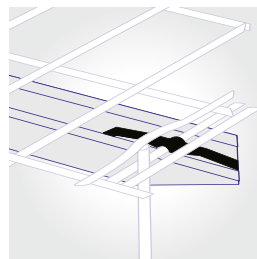

— 02

Accessories

Beam clamp

This clamp is used primarily to attach L-profile ExpressTray to steel beams. It can also be used to attach U- and C-profiles onto structural steel.

Available in ¾ in. and 1½ in. sizes in hot-dipped galvanized steel.

Express tip: Refer to page C55 for an application example.



Cat no.	Height (H)		lb/ea.	Weight kg/ea.
	in.	mm		
ETH-IBC3/4-HD	0.787	20	0.48	0.22
ETH-IBC1-HD	1.181	30	0.53	0.24

Diagram

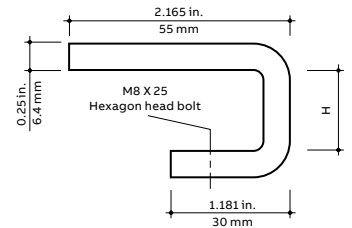

End caps

Protective cap for attachment to cut wire ends of mesh cable tray.

Cat no.	Cable tray application	Material	lb/ea.	Weight kg/ea.
ETA-EPC-6	ETU6*	Polyethylene	0.08	0.36
ETA-EPC-4	ETQ4*	Polyethylene	0.66	0.29



Superstrut hexagonal nut

For use with Superstrut threaded rod.

Available in two sizes, ¼ in. and ⅜ in., in electro-galvanized steel.

Cat no.	Size (in.)	lb/ea.	Weight kg/ea.
E145-1/4EGC	¼	0.01	0.004
E145-3/8EGC	⅜	0.01	0.004



Superstrut flat washer

For use with Superstrut threaded rod and hex nut.

Available in ¼ in. and ⅜ in. sizes, in electro-galvanized steel.

Cat no.	Size (in.)	lb/ea.	Weight kg/ea.
E147-1/4EGC	¼	0.01	0.004
E147-3/8EGC	⅜	0.01	0.004

Accessories



Superstrut short spring nut

For use with D-series metal framing channel.

Spring nuts are offered in 1/4 in. and 3/8 in. sizes in electro-galvanized steel.

Cat no.	Size (in.)	lb/ea.	Weight	
			kg/ea.	
B100-1/4EGC	1/4	0.01		0.004
B100-3/8EGC	3/8			

Bracket clamp

The bracket clamp is used for mounting tray to wall brackets or suspended support brackets and is compatible with all tray profiles.

Available in electro-galvanized steel, pregalvanized steel, hot-dipped galvanized steel and stainless steel (types 304 or 316).

Express tip: Refer to pages C50, C51 and C53 for application examples.
Tool required: 10 mm nut driver

Cat no.	Material	Weight	
		lb/ea.	kg/ea.
ETH-WBC-EG	Electro-galvanized steel	0.09	0.02
ETH-WBC-HD	Hot-dipped galvanized steel	0.09	0.02
ETH-WBC-SS	Stainless steel (type 304)	0.09	0.02
ETH-WBC-S6	Stainless steel (type 316)	0.09	0.02

A photograph showing the bracket clamp assembly, including a main metal clamp with a central hole, a smaller metal piece, and a bolt with a nut.

Diagram

A technical drawing of the bracket clamp showing dimensions: a width of 1.338 in. (34 mm) and a height of 0.866 in. (22 mm).

Standard bolting kit

The standard bolting kit consists of an M6 x 12 mm carriage bolt and capture nut.

Available in electro-galvanized steel, hot-dipped galvanized steel and stainless steel (types 304 and 316).

Tool required: 10 mm nut driver

Cat no.	Material	Weight	
		lb/ea.	kg/ea.
ETH-KIT0-EG	Electro-galvanized steel	0.02	0.01
ETH-KIT0-HD	Hot-dipped galvanized steel	0.02	0.01
ETH-KIT0-SS	Stainless steel (type 304)	0.02	0.01
ETH-KIT0-S6	Stainless steel (type 316)	0.02	0.01

A photograph showing the standard bolting kit, which includes a carriage bolt and a capture nut.

Accessories



Nestled "J" or "L" bracket bolting kit

For use with "J" and "L" brackets, this bracket bolting kit consists of an M10 x 25 mm carriage bolt and capture nut.

Available in hot-dipped galvanized steel.

Express tip: Refer to page C51 for an application example.
Tool required: 17 mm nut driver

Cat no.	Material	lb/ea.	Weight kg/ea.
ETH-KIT1-HD	Hot-dipped galvanized steel	0.09	0.04



Back-to-back bracket bolting kit

For use in back-to-back bracket configurations or for use with "L" brackets, this bracket bolting kit consists of an hexagonal M10 x 60 mm bolt, a flat washer, a lock washer and a nut.

Available in hot-dipped galvanized steel.

Express tip: Refer to page C51 for an application example.
Tool required: 17 mm nut driver

Cat no.	Material	lb/ea.	Weight kg/ea.
ETH-KIT2-HD	Hot-dipped galvanized steel	0.13	0.06



Spacers

The spacer is used to prevent spreading of the bracket profile during installation. Spacers can be used with both "L" and "J" brackets in both single and back-to-back configurations.

Available in pregalvanized and hot-dipped galvanized steel.

Express tip: Refer to pages C50–C51 for application examples.

Cat no.	Material	lb/ea.	Weight kg/ea.
ETH-S-PG	Pregalvanized steel	0.09	0.04
ETH-S-HD	Hot-dipped galvanized steel	0.09	0.04