

BROCHURE

# Superstrut® Metal Framing

## Channel & Accessories



- This guide presents a summary of the Superstrut® products, for details regarding our complete offering, consult our “Metal Framing, Fastening and Identification” catalogue at [tnb.ca.abb.com](http://tnb.ca.abb.com) or contact your local representative.

# Superstrut Metal Framing Channels

The Superstrut system is designed with many time-saving features and provides solutions for various applications such as;



- Cable Tray Supports
- Pipe & Conduit Supports
- Trapeze Hangers
- Wall Framing
- Rack and Shelving

### Finishes & Materials

| Finish on steel        |                             |
|------------------------|-----------------------------|
| BC                     | Bare Steel                  |
| PGC                    | Pre-Galvanized              |
| EGC                    | Electrogalvanized           |
| HDGC                   | Hot Dipped Galvanized       |
| GR, GY, WH...          | Epoxy Coating               |
| Other material offered |                             |
| ALC                    | Aluminum                    |
| T316L                  | Stainless Steel (Type 316L) |

### Channel hole configurations

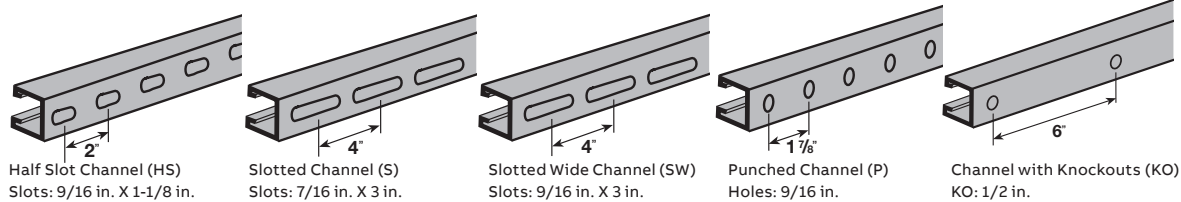

### Welded Combinations

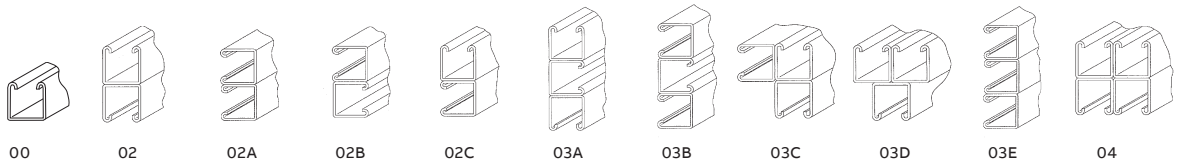

EXAMPLES: Two A1200 channels back to back are ordered as A1202. Two A1200 channels back to side are ordered as A1202C.

### Channel Series

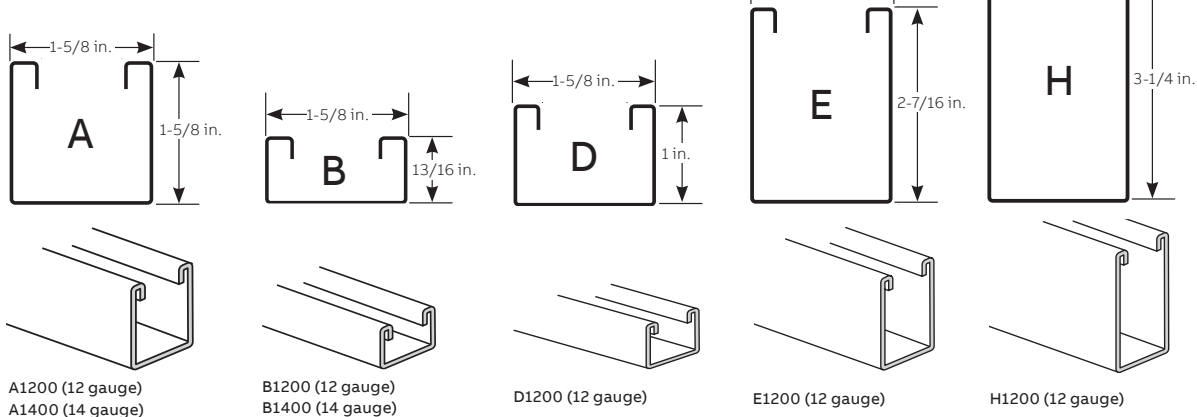

## Superstrut Metal Framing

Time Saving Solutions

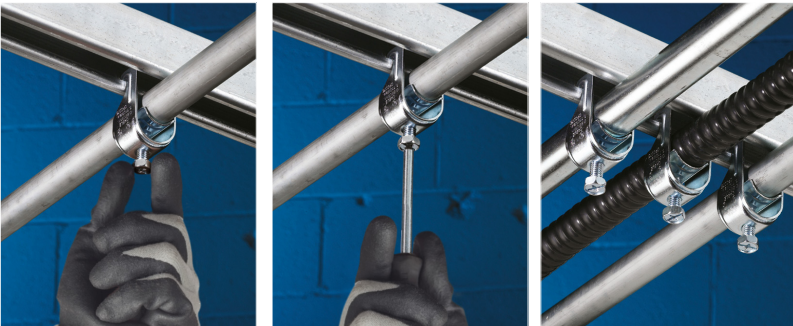

### Cobra® Clamp

One-piece, heavy duty construction, ready to install, right out of the box. Use to attach and support a full range of EMT & rigid conduits from 1/4 to 4 in. trade sizes.



| Cat. No. | Trade Size (in.) |               | Cable O.D. Range (in.) |
|----------|------------------|---------------|------------------------|
|          | EMT              | Rigid Conduit |                        |
| CPC025   | 1/4              | 1/4           | 0.312 - 0.600          |
| CPC050   | 1/2              | 1/2           | 0.650 - 0.890          |
| CPC075   | 3/4              | 3/4           | 0.860 - 1.110          |
| CPC100   | 1                | 1             | 1.100 - 1.400          |
| CPC125   | 1-1/4            | 1-1/4         | 1.400 - 1.725          |
| CPC150   | 1-1/2            | 1-1/2         | 1.690 - 1.980          |
| CPC200   | 2                | 2             | 1.980 - 2.576          |
| CPC250   | 2-1/2            | 2-1/2         | 2.576 - 3.060          |
| CPC300   | 3                | 3             | 3.060 - 3.626          |
| CPC350   | 3-1/2            | 3-1/2         | 3.626 - 4.126          |
| CPC400   | 4                | 4             | 4.126 - 4.626          |



### Bat Clip™

Flexible conduit hanger, attaches ExpressTray® to strut.

| Cat. No.  | Material and Finish                             |
|-----------|---|
| SSF-CK535 | Spring steel with zinc phosphate finish (black) |

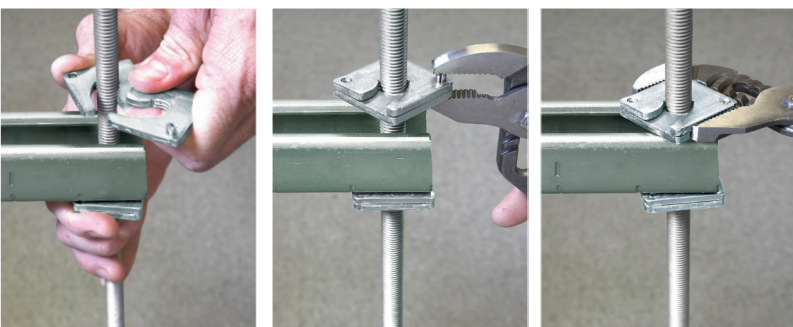

### H122 Trapnut™ Strut Fastener

Reduces time to install trapeze framing and support. Closes at any desired position, can be removed and reused.

| Cat. No.     | Size (in.) | Design load (lb) |
|--------------|------------|------------------|
| H 122 1/4 EG | 1/4        | 150              |
| H 122 3/8 EG | 3/8        | 590              |
| H 122 1/2 EG | 1/2        | 1080             |



# Superstrut Metal Framing

## Post bases and accessories

### Post bases

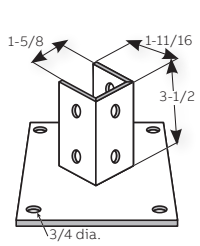

AP232

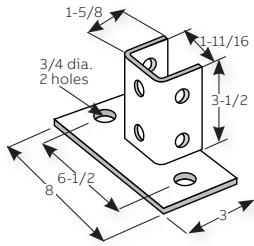

AP232FL

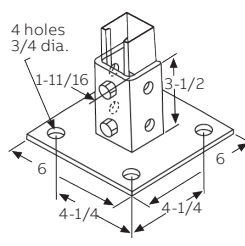

AP232SQ

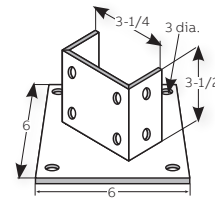

AP235

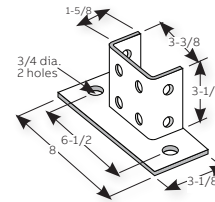

AP235FL

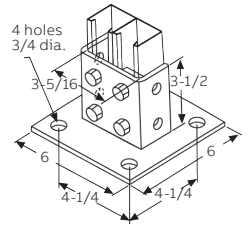

AP235SQ

### Threaded rod

Threaded rod is used to suspend metal framing channel from ceilings. Available thread sizes: 1/4 to 1 in.



H104 Series

### U shape channel inside joiner

SJ-12-PG is for A1200 Series.  
SJ-14-PG is for A1400 Series.



SJ-12-PG  
SJ-14-PG

### Universal channel cone nuts

One size fits all strut depths. Used to connect modular framing channels to accessories. (Available in a GoldGalv® finish)

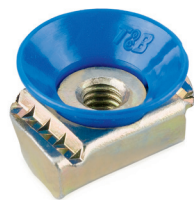

UCN Series

### Cable tie mounting base

Fits all 1-5/8 in. channels.



TC5363X

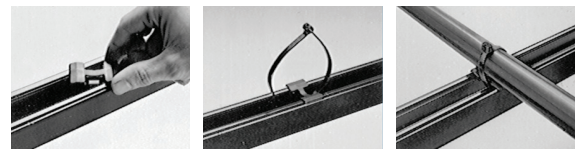

### Spring nut

Self-aligning spring nuts are designed to provide resistance to pull-out and side slip. Available sizes: 1/4 to 5/8 in.

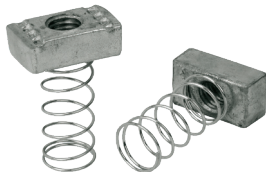

A100 & B100 Series

### Strut cover & end cap

For a clean finish and professional appearance after wiring has been completed. Available in pre-galvanized and plastic.

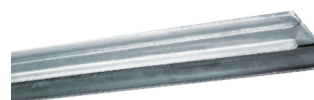

AB844 Series

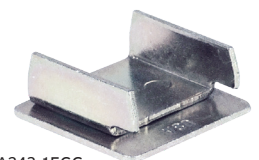

A243-1EGC  
For A1200 channels.



# Superstrut Metal Framing

Fittings for an easy installation

## Flat fittings

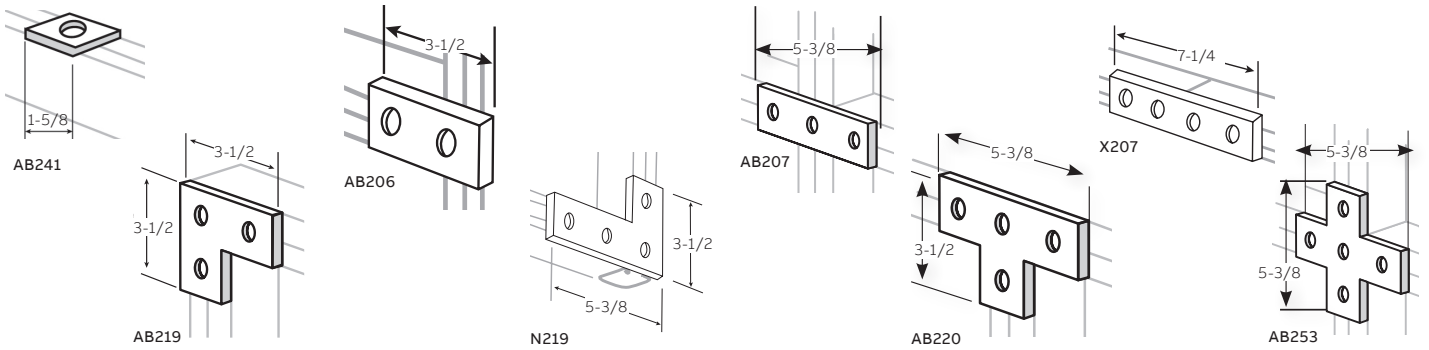

## Angular fittings

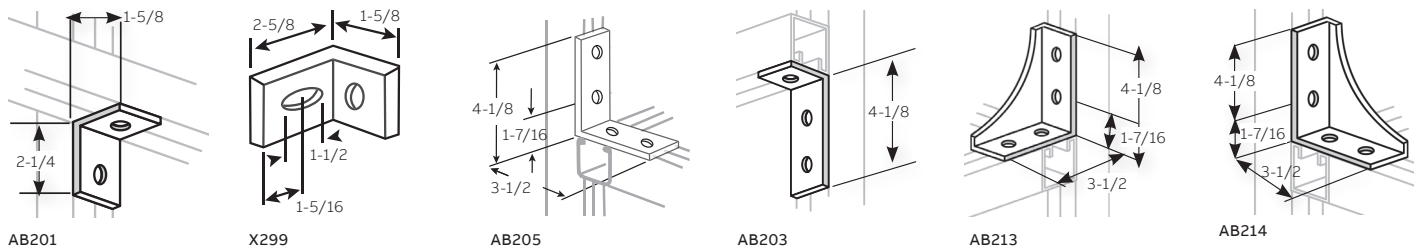

## Shaped fittings

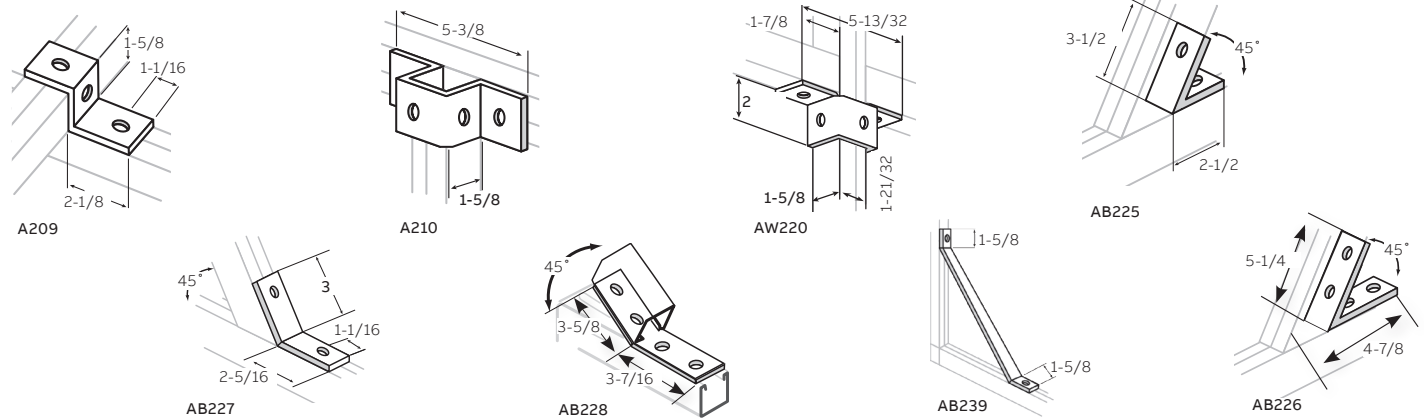

## Supermag™ magnetic fittings



Nickel-plated magnets embedded in the most popular Superstrut steel fittings. Adds convenience and safety to strut assembly by eliminating the need to manually hold fittings and strut together while installing bolts, nuts and rods.



AB241M  
Square Washers for  
1/4 to 1/2 in. bolts



AB202M  
90° Angle  
Fitting



AB205M  
90° Angle  
Fitting



AB219M  
Flat  
L-Bracket



AB220M  
Flat  
L-Bracket

## Superstrut Metal Framing

Cable and Pipe Clamps to install quickly and securely

### Quik clamp™

One-piece construction integral bolt and captive nut for EMT & rigid conduits 1-1/2 to 4-11/16 in. trade sizes.



TBQC series

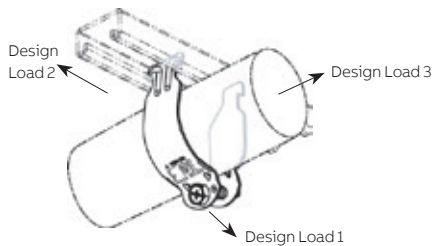

Design load 1: 200 to 350 lb  
Design load 2-3: 50 lb

### Conduit & pipe clamp

Two-piece, heavy-duty construction for EMT & rigid conduits; 1/2 to 4 in. trade sizes. Machine screw and nut included.

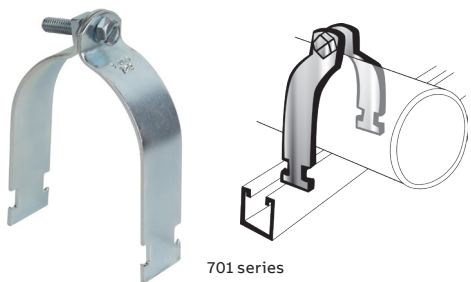

701 series

### Conduit & pipe hanger

Accommodates 3/8 in. up to 4 in. EMT & rigid conduits  
Load rating 500 lb

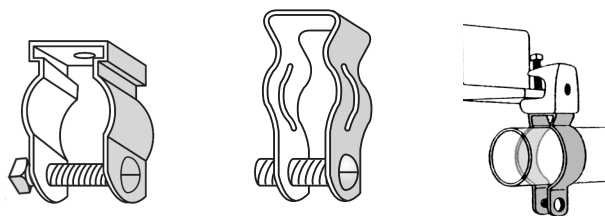

6H-B  
with bolt and hex nut

6H-TB  
Threaded  
with bolt

### Support brackets

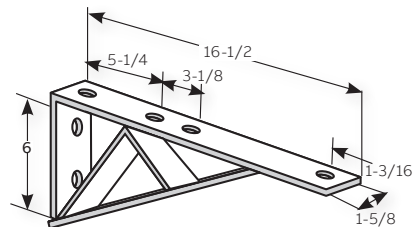

S222  
Load rating  
750 lb to 1,000 lb

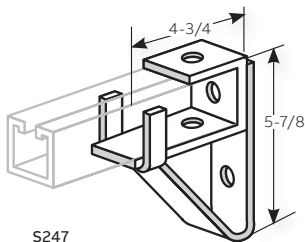

S247  
Load rating  
3,650 in. lb to 5,250 in. lb

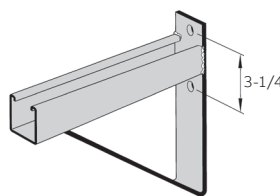

S249  
Load rating  
600 to 1,600 lb

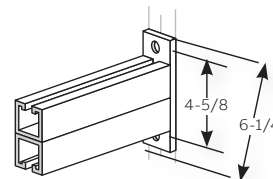

S251 / S256  
Load rating  
500 to 1,650 lb

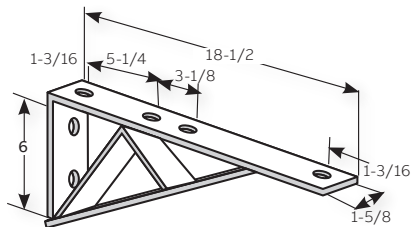

S226  
Load rating  
750 to 1,000 lb

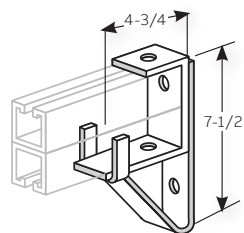

S248  
Load rating  
7,550 in. lb to 10,800 in. lb

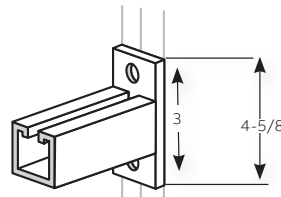

S250  
Load rating  
400 to 1,500 lb

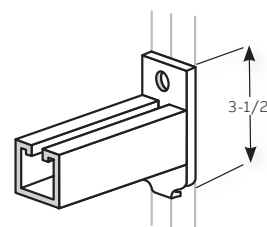

S256  
Load rating  
250 to 1,000 lb

## Superstrut Metal Framing

### Beam Clamps and Hanger Supports

#### Beam clamps for hanging rods

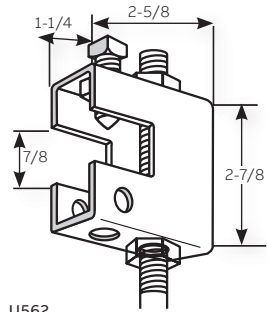

**U562**  
For rod size 1/2 in.  
Load rating 500 to 800 lb

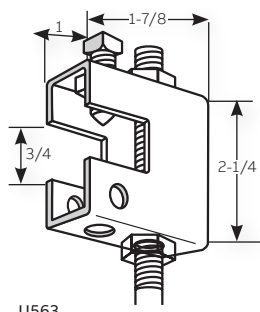

**U563**  
For rod size 3/8 in.  
Load rating 240 to 400 lb

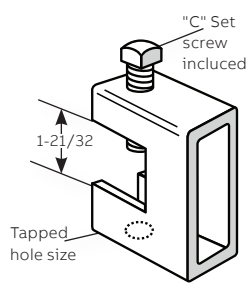

**U564**  
For rod size 3/8 in. -1/2 in. -5/8 in.  
Load rating 1,300 to 3,150 lb

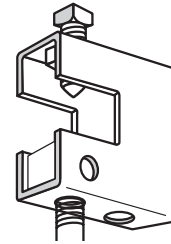

**UM562**  
For rod size 1/2 in.  
Design load 1,200 lb

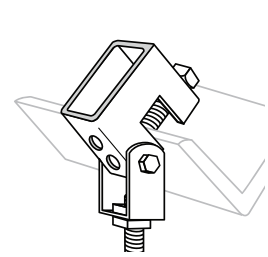

**U5562**  
For rod size 1/2 in.  
Design load 800 lb

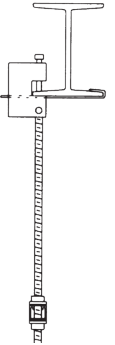

#### Beam clamps for mounting channel

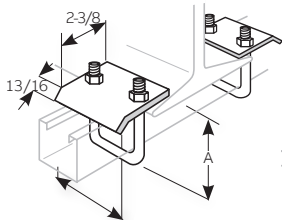

**U501-U502**  
Load rating  
2,150 to 3,000 lb.

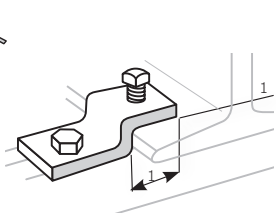

**U510**  
Load rating  
800 to 1,000 lb

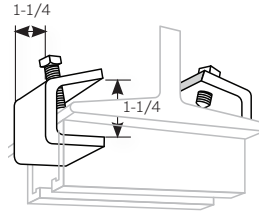

**U514**  
Load rating 750 lb per pair

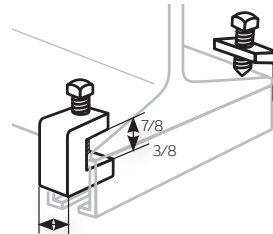

**U514A**  
Load rating 1,650 lb per pair

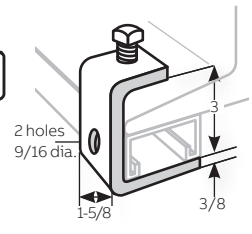

**U515**  
Load rating 800 lb

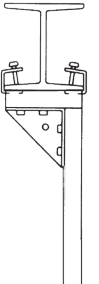

#### Channel support beam clamps

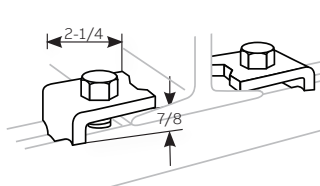

**512U**  
Load rating  
800 to 1,000 lb

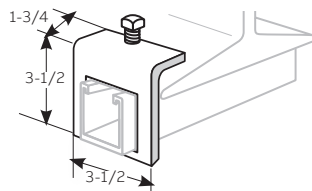

**A597**  
Load rating  
800 lb

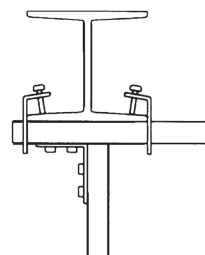



---

**ABB Electrification Canada ULC  
Installation Products**

700 Thomas Avenue  
Saint-Jean-sur-Richelieu, Quebec J2X 2M9  
Tel.: +1 (450) 347 5318  
Toll Free: +1 (800) 362 2952  
Fax: +1 (450) 347 1976

---

**Regional Sales Offices**

**Atlantic Provinces**

Tel.: +1 (902) 450 1307  
Toll Free: +1 (877) 862 4357  
Fax: +1 (902) 450 1309

**Quebec**

Tel.: +1 (450) 466 1102  
Toll Free: +1 (800) 465 1399  
Fax: +1 (450) 466 1163

**Ontario**

Tel.: +1 (905) 635 7888  
Toll Free: +1 (877) 291 7771  
Fax: +1 (905) 635 7889

**Manitoba / Saskatchewan**

Tel.: +1 (604) 598 9811  
Toll Free: +1 (866) 540 8220  
Fax: +1 (604) 598 9840

**Alberta**

Tel.: +1 (780) 424 7092  
Toll Free: +1 (888) 664 5666  
Fax: +1 (780) 424 7093

**British Columbia**

Tel.: +1 (604) 598 9811  
Toll Free: +1 (866) 540 8220  
Fax: +1 (604) 598 9840

**[tnb.ca.abb.com](http://tnb.ca.abb.com)**