

Large Housing



Class I — Zone 2, Groups IIC, IIB, IIA,
Exn R II T3 (Restricted Breathing†)
— Division 2, Groups A, B, C and D
Class II — Division 1 and 2, Groups E, F and G
Class III

•UL Listed (UL1598) for Marine Locations
•NEMA 4X, IP66



Hazlux 3 Large Housing Catalogue Numbering System

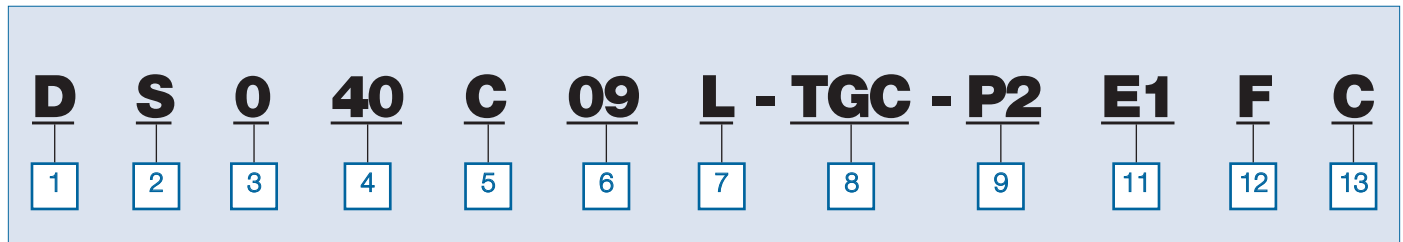

- 1** — **Fixture Series**
D = Hazlux® 3 Fixture
- 2** — **Lamp Type**
S = High Pressure Sodium
H = Metal Halide
- 3** — **Starter Circuit/Quartz Options**
O = Standard Fixture
P = Pulse Start (MH Only)
Q = Quartz Auxiliary Option (Not Hazardous Rated)
R = Instant Restart (HPS Only)
J = Auto Shutoff Starter (HPS Only)
- 4** — **Lamp Wattage**
20 = 200 Watts
25 = 250 Watts
32 = 320 Watts (MH PS Only)
40 = 400 Watts
- 5** — **Ballast Circuit**
H = High Reactance
C = Constant Wattage Autotransformer
(All ballasts high power factor.)
I = Constant Wattage Isolated (CWI)
- 6** — **Voltage/Frequency**
09 = 120/277/347V, 60Hz
12 = 120V, 60Hz
24 = 240V, 60Hz
27 = 277V, 60Hz
28 = 208V, 60Hz
34 = 347V, 60Hz
225 = 220V, 50Hz
245 = 240V, 50Hz
- 7** — **Ballast Housing Style**
L = Large Housing (200-400W HPS; 400W MH)
- 8** — **Optics and Guards**
R2 = 12 in. Glass Refractor Globe, Type II
R5 = 12 in. Refractor Globe, Type V
R2G = R2 with Steel Wire Guard
R5G = R5 with Steel Wire Guard
RCB = Enclosed High Bay Reflector
R5P = RCB with Steel Wire Guard
- 8** — **Optics and Guards (Cont'd)**
TG = 7-3/4 in. Thermal Shock Resistant Globe
TGC = TG with Cast Aluminum Guard
SG = Tuffskin® Coated Globe
SGC = SG with Cast Aluminum Guard
- 9** — **Mounting Style**
A2 = 3/4 in. Cone Top Pendant
A3 = 1 in. Cone Top Pendant
B2 = 3/4 in. Wall Mount
B3 = 1 in. Wall Mount
C2 = 3/4 in. Ceiling Mount
C3 = 1 in. Ceiling Mount
F2 = 3/4 in. Flexible Pendant
F3 = 1 in. Flexible Pendant
HV1 = Hazvertor™ Ring - Class I, Div. 2, Zone 2
L4 = 1-1/4 in. Straight Stanchion
L5 = 1-1/2 in. Straight Stanchion
P2 = 3/4 in. Rigid Pendant
P3 = 1 in. Rigid Pendant
S4 = 1-1/4 in. 25° Angle Stanchion
S5 = 1-1/2 in. 25° Angle Stanchion
- 10** — **Special Options**
T = Haz-Cote™ Custom Corrosion Coating
(Consult Factory)
- 11** — **Hazpak® Options**
E = Hazpak with Clear Lamp
E1 = Hazpak, Clear Lamp, Dome Reflector
E2 = Hazpak Clear Lamp, Angle Reflector
D = Hazpak with Dual Arc Lamp
D1 = Hazpak, Dual Arc Lamp, Dome Reflector
D2 = Hazpak, Dual Arc Lamp, Angle Reflector
U = Hazpak, No Lamp
- 12** — **Fusing Options ***
F = Single Fuse Block with Fuse
FF = Double Fuse Block with Fuse
- 13** — **CSA Certification**
C = CSA Nameplate





*Not CSA certified in hazardous locations

†With appropriate fittings installed





Hazlux

Hazlux 3, Large Housing Accessories

OUTLET BOXES

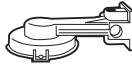
MOUNTING STYLE	CAT. NO.	CONDUIT HUB SIZE
Rigid Pendant 	VP2 VP3	3/4" 1"
Cone Pendant 	VA2 VA3	3/4" 1"
Flexible Pendant 	VF2 VF3	3/4" 1"
Ceiling Mount 	VC2 VC3	3/4" 1"

OUTLET BOXES

MOUNTING STYLE	CAT. NO.	CONDUIT HUB SIZE
Wall Mount 	VB2 VB3	3/4" 1"
Angle Stanchion 	VS4 VS5	3/4" 1"
Straight Stanchion 	VL4 VL5	3/4" 1"
Adaptor Ring 	HV1	N.A.

GLOBES OR REFRACTORS

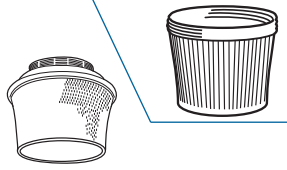
	CATALOGUE NO.	DESCRIPTION
	VGT31	7-3/4" dia. Heat Resistant Globe (400W max.)
	VGT31TS	7-3/4" dia. Heat Resistant Globe (400W max.) coated with Tuff®-Skin®
	VRF31C2	12" dia. IES Type II Refractor, 7-3/4 Thread
	VRF31C5	12" dia. IES Type V Refractor, 7-3/4 Thread

REFLECTORS

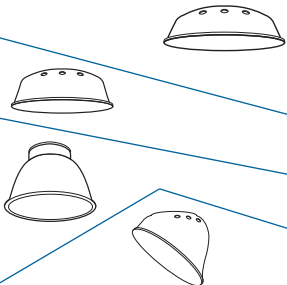
	CATALOGUE NO.	DESCRIPTION
	VR31P	Standard Dome, Fiberglass Reinforced Polyester
	VRD31	Deep Dome, Anodized Aluminum
	VR31CB	Enclosed High Bay, Anodized Aluminum with Lens
	VRA31P	30° Angle Reflector, Fiberglass Reinforced Polyester

GUARDS

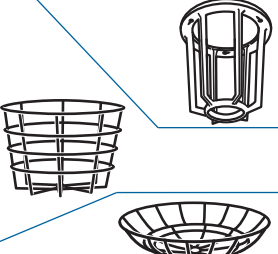
	CATALOGUE NO.	DESCRIPTION
	VGU31	Cast Aluminum Guard for VGT31 Globe
	VGR48	Steel Wire Guard for All VRF Series 12" Refractors
	VGR64	Steel Wire Guard for VR31CB Enclosed High Bay Reflector

Large Housing

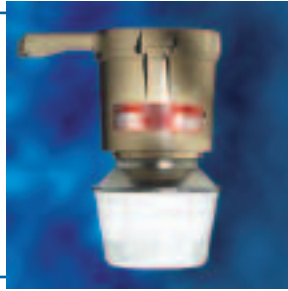

- Class I — Zone 2, Groups IIC, IIB, IIA, Exn R II T3 (Restricted Breathing*)
- Division 2, Groups A, B, C and D
- Class II — Division 1 and 2, Groups E, F and G
- Class III
- UL Listed (UL1598) for Marine Locations
- NEMA 4X, IP66



Hazlux 3, Large Housing Dimensions

LARGE BALLAST HOUSING WITH GLOBE AND GUARD

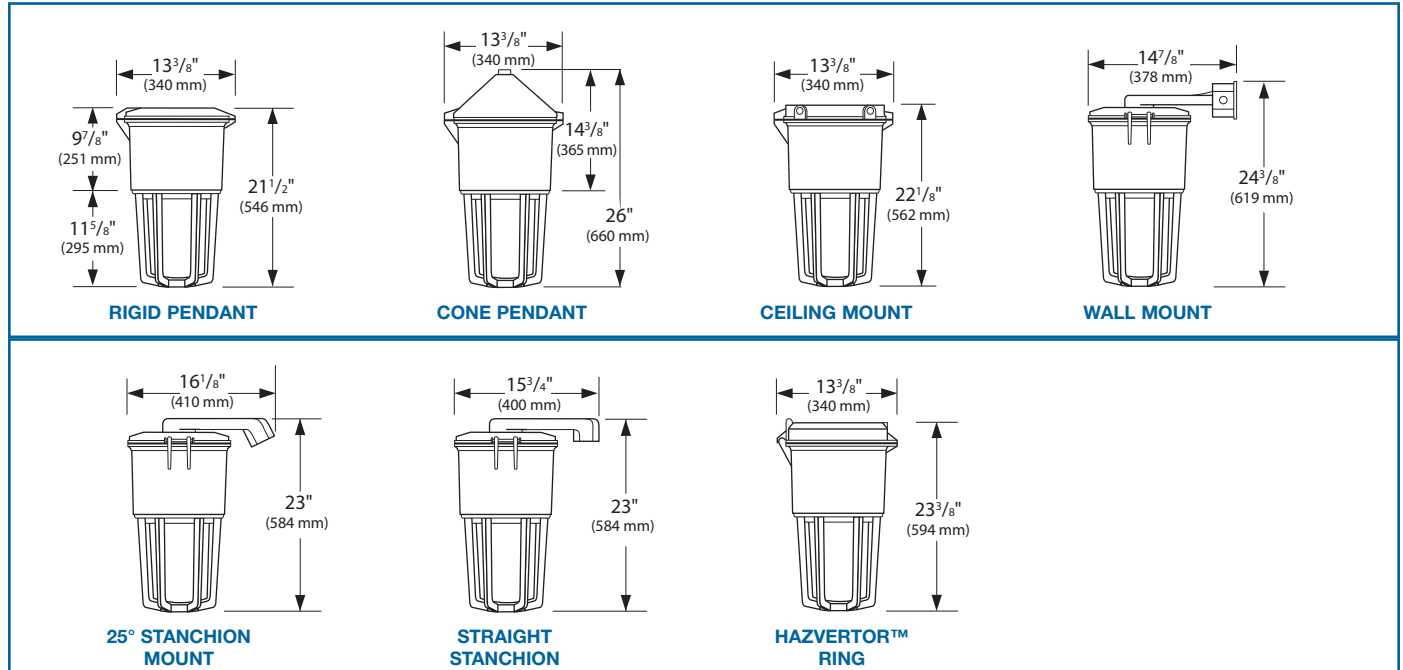

LARGE BALLAST HOUSING WITH 12" REFRACTOR AND GLOBE

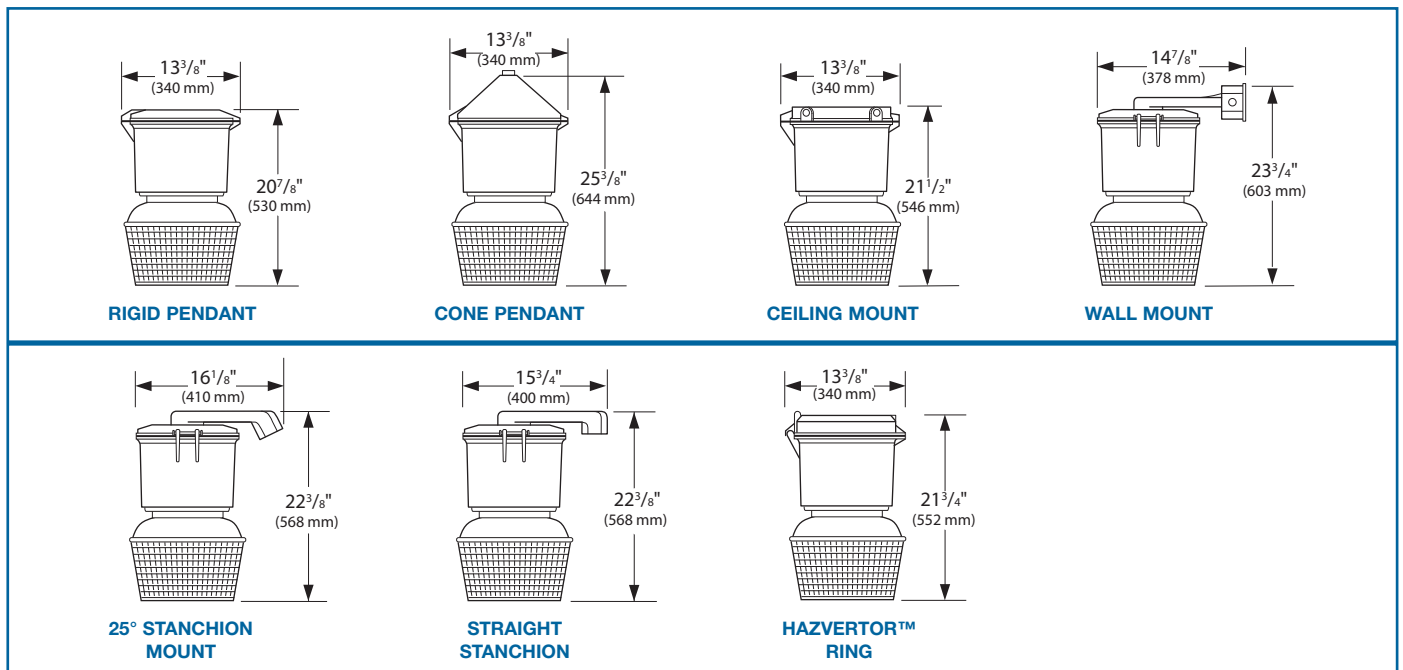

*With appropriate fittings installed