







Specifications

Access Floor Module Size		AFM-2
AFM Depth		4"
Access Floor Cut-Out		7-1/8" x 4-1/8"
AFM Cover Size		6-3/4" x 3-7/8"
AFM Cover Access Area		17 sq in
Box Volume (Less Panels)		75 cu in
Device	45° Power	16.2 cu in.
Compartment		
Volume		
Power Panel Included		AFP-2A
Cover/Carpet Flange Material		Nylon-6
Body Material		14 ga galvanized steel
Max. No. of Device Panels		2

Devices not included
Nylon carpet flange available in Black, Gray, Brown or Beige

AFM-2

	POWER PANELS	DATA PANELS	ACCESSORIES
AFM-2-BLK GRY BRN BGE	 <p>AFP-2A* single duplex</p>  <p>AFP-2B blank</p>	 <p>AFD-2J 1 IBM set</p>	 <p>AFT-2 power tunnel</p>  <p>AFR-2** mounting flange</p>

* (1) supplied with box

** Used to correct opening in floor. Not required for all installations.

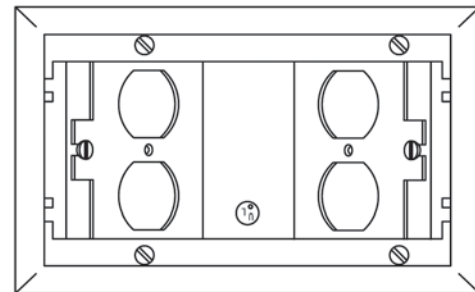
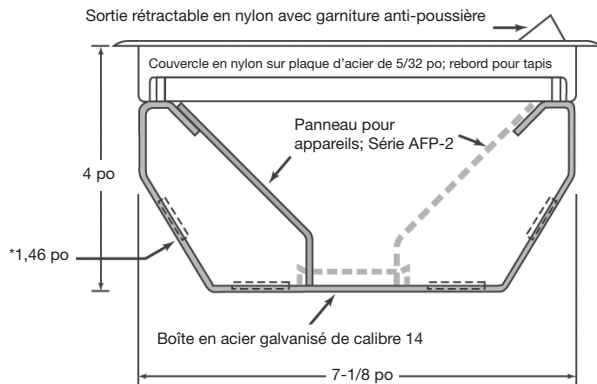

AFM-2
Shown with supplied power panel and optional panel (sold separately).





AFM-4

Specifications

Access Floor Module Size	AFM-4
AFM Depth	4"
Access Floor Cut-Out	7-15/16" x 7-15/16"
AFM Cover Size	7-5/8" x 7-5/8"
AFM Cover Access Area	39 sq in
Box Volume (Less Panels)	150 cu in
Device	45° Power 27.3 cu in 60° Power 25.2 cu in
Compartment	Center Data 20.6 cu in
Volume	Power — Data —
Base Opening	2" x 2-7/8"
Power Panel Included	AFP-4A
Cover/Carpet Flange Material	Nylon-6
Body Material	14 ga galvanized steel
Max. No. of Device Panels	3

Devices not included

Nylon carpet flange available in Black, Gray, Brown or Beige

	POWER PANELS		DATA PANELS		ACCESSORIES	
AFM-4-BLK GRY BRN BGE	AFP-4A* single duplex-45° 	AFP-4A60 single duplex-45° 	AFP-4-GFCI single GFCI-60° 	AFD-4A single duplex data 	AFD-4B Blank 	AFT-46 power tunnel
	AFP-4B blank-45° 	AFP-4B60 blank-60° 			AFD-4 4RJ Keystone style jacks 	AFR-4** mounting flange
					AFC-N Grommeted closure panel 	AFM-4EX extension collar

* (1) ea. supplied with box.

** Used to correct opening in floor. Not required for all installations.

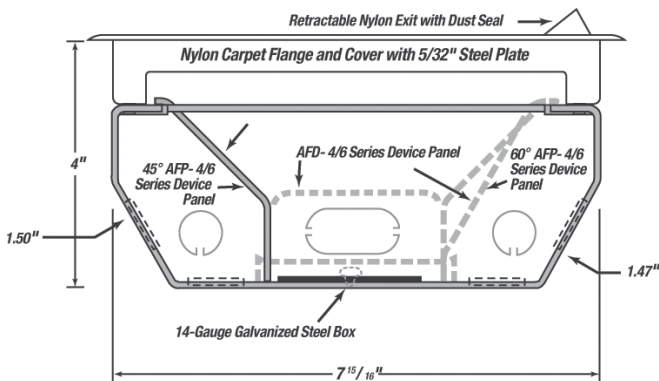

Shown with supplied power panel and optional data panel and 45° power panel (sold separately).

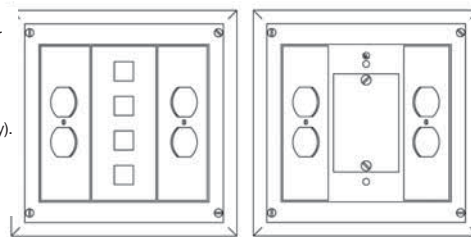

Shown with optional 60° power panels (sold separately).



Access Floor Modules

Steel City®

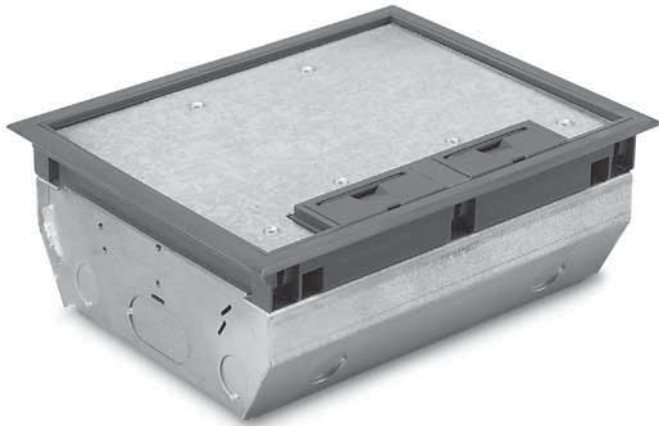

AFM-6

Specifications

Access Floor Module Size		AFM-6
AFM Depth		4
Access Floor Cut-Out		7-15/16"x10"
AFM Cover Size		7-5/8"x9-3/4"
AFM Cover Access Area		60 sq in
Box Volume (Less Panels)		225 cu in
Device	45° Power	41.5 cu in
Compartment	60° Power	38.3 cu in
Volume	Center Data	31.3 cu in
		—
Base Opening		2"x2-7/8"
Power Panel Included		AFP-6Q
Cover/Carpet Flange Material		Nylon-6
Body Material		14 ga galvanized steel
Max. No. of Device Panels		3

Devices not included
Nylon carpet flange available in Black, Gray, Brown or Beige

	POWER PANELS	DATA PANELS	ACCESSORIES
AFM-6-BLK GRY BRN BGE	AFP-6Q* double duplex-45° 	AFP-6B blank-45° 	AFD-46 power tunnel
	AFP-6A single duplex-45° 	AFP-6B60 blank-45° 	AFR-4** mounting flange
	AFP-6R60 double duplex-60° 	AFP-6-GFCI double GFCI-60° 	AFC-N Grommeted closure panel
	AFP-6A60 Single duplex-60° 	AFP-6-GFCI-45 double GFCI-45° 	AFM-6EX extension collar
		AFD-6Q double duplex data 	AFD-6M 2 telephone - 4 coax
		AFD-6L 2 IBM sets 	AFD-6B blank
		AFD-6K 2 telephone 	AFD-6 6RJ Keystone style jacks
			AFD-6A Single duplex

* (1) supplied with box

** Used to correct opening in floor. Not required for all installations.

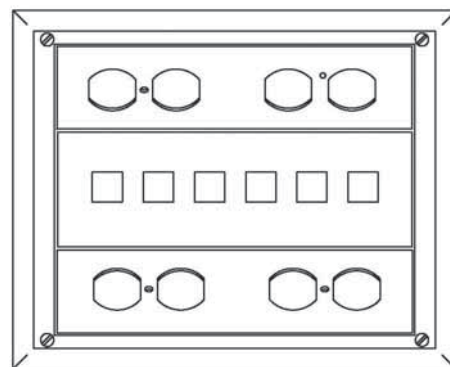
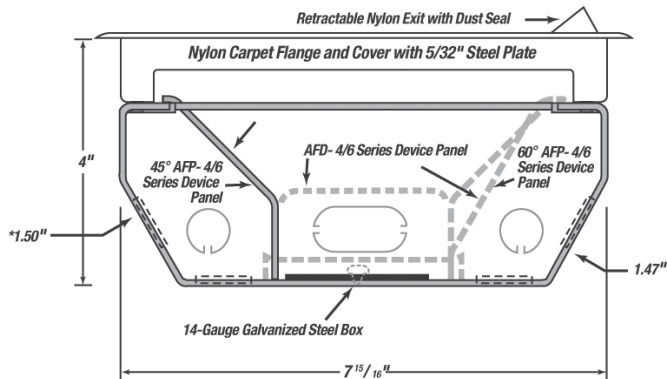

AFM-6
Shown with supplied power panels and optional panels
(sold separately).





AFM-6S-2

Specifications

Access Floor Module Size	AFM-6S
AFM Depth	2-1/2"
Access Floor Cut-Out	7-15/16" x 10"
AFM Cover Size	7-5/8" x 9-3/4"
AFM Cover Access Area	60 sq in
Box Volume (Less Panels)	172 cu in
Device	45° Power — 60° Power —
Compartment	Center Data —
Volume	Power 13.1 cu in Data 6.6 cu in
Base Opening	—
Power Panel Included	AFP-6S2-L, AFP-6S2-R
Cover/Carpet Flange Material	Nylon-6
Body Material	14 ga galvanized steel
Max. No. of Device Panels	*

Devices not included

* 6 maximum (data only) and 4 standard (2 power, 2 data)
Nylon carpet flange available in Black, Gray, Brown or Beige

POWER PANELS	DATA PANELS	ACCESSORIES
AFP-6S2-R (L) single duplex (R-right side; L-left side) AFP-6S2-GR (-GL) single GFCI AFP-6S2-BR (-BL) blank	AFD-6S2-2RJ Keystone style jacks	AFR-6 mounting flange Used to correct opening in floor. Not required for all installations.

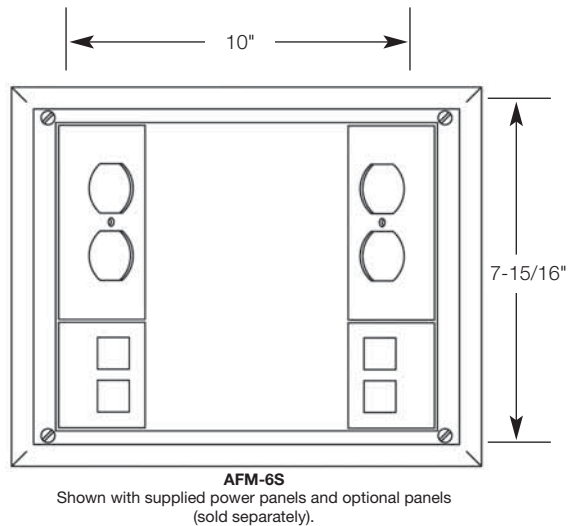
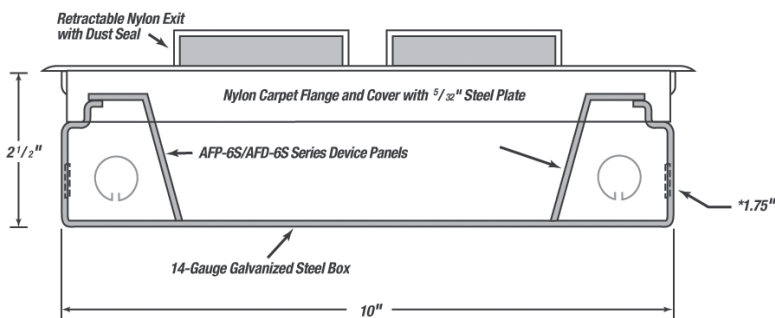







AFM-6V

Specifications

Access Floor Module Size	AFM-6
AFM Depth	4.70"
Access Floor Cut-Out	7-15/16" x 10"
AFM Cover Size	7-5/8" x 9-3/4"
AFM Cover Access Area	60 sq in
Box Volume (Less Panels)	201 cu in
Device	45° Power — 60° Power —
Compartment	Center Data —
Volume	Power 51 cu in Data 51 cu in
Base Opening	1.72" x 5.28"
Data Panel Included	AFD-6V-2F
Power Panel Included	AFP-6V-3D
Closure Panel Included	Yes
Cover/Carpet Flange Material	Nylon-6
Body Material	14 ga galvanized steel
Max. No. of Device Panels	2

Devices not included
Nylon carpet flange available in Black, Gray, Brown or Beige

POWER PANELS	DATA PANELS	ACCESSORIES
<p>AFM-6V-BLK GRY BRN BGE</p> <p>AFP-6V-3D* three duplex</p>  <p>AFP-6V-3G three GFCI</p> 	<p>AFD-6V-2F* two single gang data face plates</p>  <p>AFD-6S-B Blank</p> 	<p>AFR-6 mounting flange</p>  <p>Used to correct opening in floor. Not required for all installations.</p>

* (1) AFP-6V-3D and (1) AFD-6V-2F supplied with box.

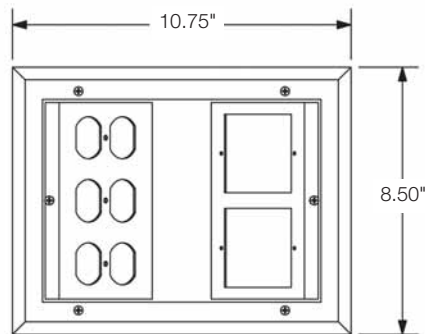
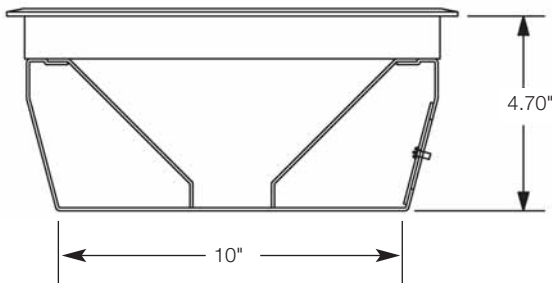

AFM-6V
Shown with supplied power panel and optional panel (sold separately).



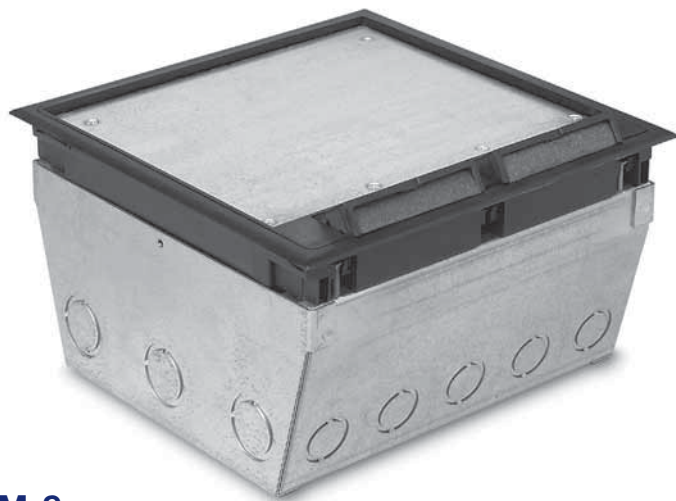







Specifications

Access Floor Module Size	AFM-8
AFM Depth	5-5/8"
Access Floor Cut-Out	9-5/8" x 9-5/8"
AFM Cover Size	9-3/8" x 9-3/8"
AFM Cover Access Area	74 sq in
Box Volume (Less Panels)	325 cu in
Device	45° Power — 60° Power —
Compartment	Center Data —
Volume	Power 15.75 cu. in. Data 15.75 cu. in.
Base Opening	—
Cover/Carpet Flange Material	Nylon-6
Body Material	14 ga galvanized steel
Max. No. of Device Panels	10

Devices not included
Nylon carpet flange available in Black, Gray, Brown or Beige

AFM-8

POWER PANELS	DATA PANELS	ACCESSORIES
AFM-8-BLK AFM-8-GRY AFM-8-BRN AFM-8-BGE	AFP-8A single duplex  AFP-8G single GFCI  AFP-8B blank  AFD-8J 1 IBM set  AFD-8 3RJ Keystone 	AFR-8** Mounting Flange  Used to correct opening in floor. Not required for all installations.

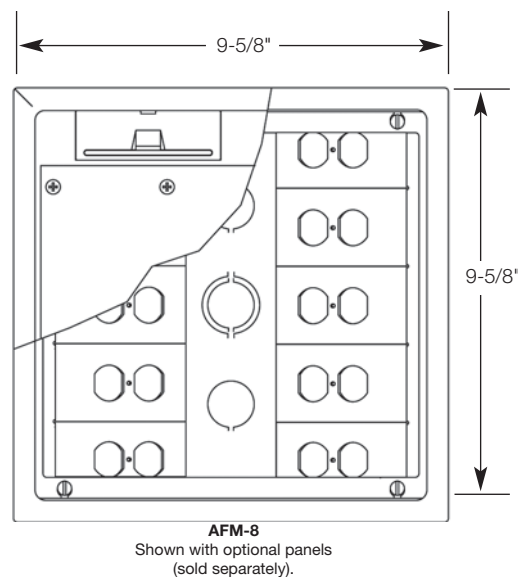
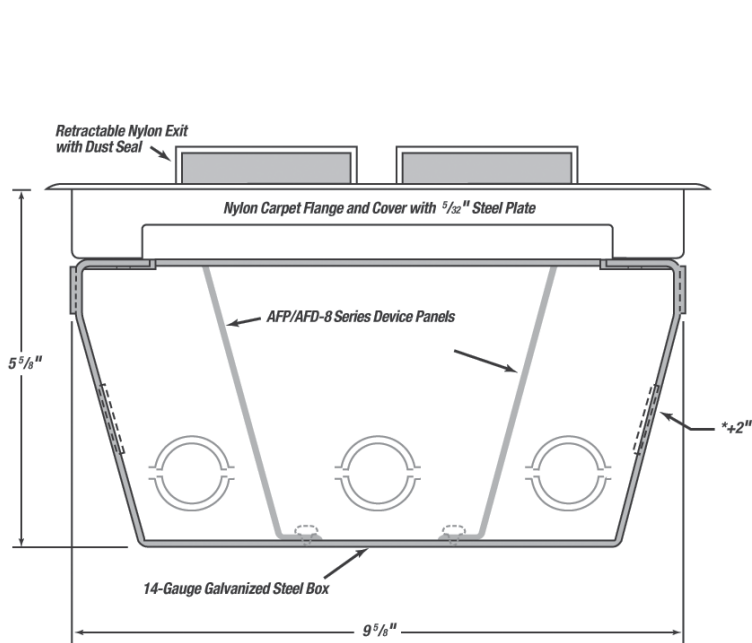

Access Floor Modules

Steel City[®]

For use with the AFM insert. The GAB cast Pre-Set includes center collar and styrene insert to prevent concrete ingress. Standard conduit hubs are 3/4" and 1-1/4".

Base Presets - Required for installation in concrete pours only.

Cat. No.	Dimensions			Maximum Capacity (cu. in.)	Standard Conduit Tapping	Maximum Conduit Tapping	AFM Insert	Std. Ctn.
	A	B	C					
GAB-4	4-1/4"	9"	16"	150	2 - 3/4" 2 - 1-1/4"	1-1/2"	AFM-4	1
GAB-6	4-1/4"	9"	16"	225	2 - 3/4" 2 - 1-1/4"	1-1/2"	AFM-6	1
GAB-8S	5-7/8"	9-3/4"	16-3/8"	325	2 - 3/4" 2 - 1-3/4"	-	AFM-8	1

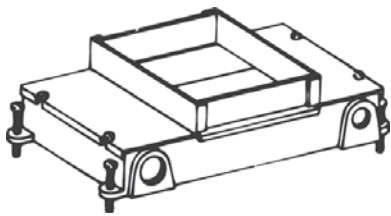

GAB-4
Cast iron base

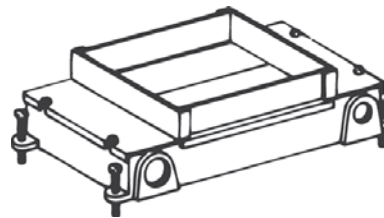

GAB-6
Cast iron base

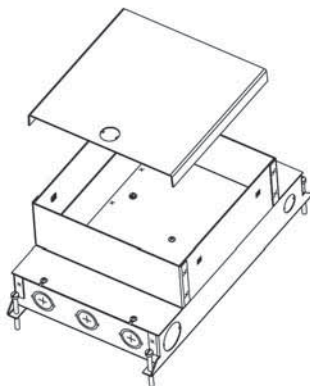
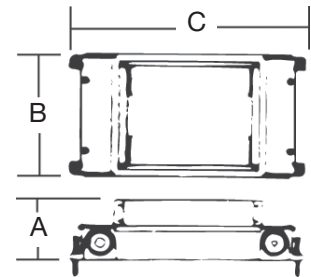

GAB-8S
Stamped Steel Base

